

# Digital 3-phase Overcurrent & Ground Overcurrent Relay Manual

TYPE : GDR-AB01

2006. 7. 18

Version 1.00



**Kyongbo Electronics Co., Ltd.**

## Safety Precautions

This document is for the safety of the user, and to prevent property damage. Be sure to read the user manual carefully, and use the product accordingly. The user manual must be kept in a place where it can be easily seen by the product user.



### WARNING

This symbol indicates the possibility of death or serious injury.



### CAUTION

This symbol indicates the possibility of injury or damage to properties only.

## SYMBOLS



Be sure not to do.



Be sure to follow the instruction.



## WARNING



- Do not perform any wiring work while the power is on or the product is in operation.

It may cause an electric shock.



- Must verify the status of the grounding connection before starting the operation.

Otherwise, it may cause an electric shock, damage, or a fire.



- Do not operate the product with wet hands.

It may cause an electric shock.



- Do not use if the clothing of the cable is damaged.

It may cause an electric shock.



- Do not perform any wiring work when the main cable is live.

It may cause an electric shock, and a damage or a fire by the charged voltage of the converter.



- Do not disassemble the product even if the power is not on, except for wiring or maintenance.

It may cause an electric shock by the charged current in the product.



- Let the electrical technician to perform wiring, test run, and maintenance.

Otherwise, it may cause an electric shock or a fire by a wrongful operation.



- Perform terminal work when cutting a cable.

Otherwise, it may cause an electric shock from the naked part of the cable.



- Place the terminal cover on the terminal in the back after the wiring work.

Otherwise, it may cause an electric shock.



## CAUTION



- Apply the rated power to the power source terminal.  
Otherwise, it may cause a damage to the product or a fire.



- Follow the rated load on the input and output connections.  
Otherwise, it may cause a damage to the product or a fire.



- Prevent screws, metal parts, water, or oil from entering the product.  
It may cause a damage to the product or a fire.



- Do not let the product be exposed to a direct sunlight.  
It may cause a damage to the product.



- Extract and insert Case on a leveled surface.  
Otherwise, it may cause a damage to the product.



- Do not store the product in a humid or a dusty area.  
It may cause a damage to the product.

# Table of Contents

## Order of Titles

<b>1. General Features</b> .....	9
<b>2. Technical Data</b> .....	10
2.1 Current Input .....	10
2.2 Rated Control Source Voltage .....	10
2.3 Rated Frequency .....	10
2.4 Case .....	10
2.5 Time Overcurrent .....	11
2.6 Instantaneous Overcurrent .....	11
2.7 Time Ground Overcurrent .....	12
2.8 Instantaneous Ground Overcurrent .....	12
2.9 Output Contacts .....	13
2.10 Insulation Test .....	14
2.11 Mechanical Test .....	15
2.12 Noise Test .....	15
2.13 Temperature, Humidity Test .....	16
2.14 Other Operating Condition .....	16
<b>3. Protection Characteristics</b> .....	17
3.1 3-Phase Overcurrent Function .....	17
3.2 Ground Overcurrent Function .....	20
<b>4. Subsidiary Function</b> .....	21
4.1 Metering .....	21
4.2 Communication .....	21
4.2.1 RS-232C Communication .....	22
4.2.2 RS-485C Communication .....	22
4.3 Self Diagnosis Function .....	23
4.4 Fault Recording Function .....	23
<b>5. Display Panel Construction</b> .....	24
5.1 Front-side Display Panel Structure .....	24
5.2 Key Pad & Communication Connector .....	25
5.3 LED ( Operating Indicators ) .....	25

<b>6. Display &amp; Setting Modes</b> .....	26
6.1 Key Operations and LCD Construction .....	26
6.1.1 LCD Default Display Condition, Backlight On/Off .....	26
6.1.2 LCD Screen Display and Principles of Key Operation .....	26
6.1.3 One-button Display .....	26
6.1.4 Menu-Tree .....	26
6.2 Setting Modes .....	27
6.2.1 Measurement Screen .....	29
6.2.2 Protection Setting .....	29
6.2.2.1 Protection ▶ Time OCR Setting .....	29
6.2.2.2 Protection ▶ INST. OCR Setting .....	30
6.2.2.3 Protection ▶ Time OCGR Setting .....	31
6.2.2.4 Protection ▶ INST. OCGR Setting .....	31
6.2.3 Self-Diagnosis Screen .....	32
6.2.4 RS-485 Comm. Setting .....	32
6.2.5 System Config. Setting .....	33
6.2.5.1 System Config. ▶ Power system Setting .....	33
6.2.5.2 System Config. ▶ T/S Output Setting .....	35
6.2.5.3 System Config. ▶ Password Setting .....	37
6.2.6 Recorder .....	38
6.2.6.1 Recorder ▶ 1.Display Fault Screen .....	38
6.2.6.2 Recorder ▶ 2.Clear Fault Category .....	39
6.2.7 Test .....	39
6.2.7.1 Test ▶ Display Test .....	40
6.2.7.2 Test ▶ Contact Test .....	41
<b>7. PC Software ( SetGDRSeries )</b> .....	42
7.1 Program Menu .....	43
7.2 Device Selecting .....	44
7.3 Communication Port Configuration .....	44
7.4 Setting Value Change Screen .....	45
7.4.1 Setting .....	45
7.4.2 Status .....	46
7.4.3 Report .....	48
7.5 Help .....	49

## Order of Table

【Table 2.1】	Input Current .....	10
【Table 2.2】	Rated Control Power .....	10
【Table 2.3】	Case .....	10
【Table 2.4】	Time Overcurrent Element .....	11
【Table 2.5】	Instantaneous Overcurrent Element .....	11
【Table 2.6】	Time Ground Overcurrent Element .....	12
【Table 2.7】	Instantaneous Ground Overcurrent Element .....	12
【Table 2.8】	Output Contacts / Capacity .....	13
【Table 2.9】	Insulation .....	14
【Table 2.10】	Vibration, Shock, Earthquake .....	15
【Table 2.11】	Noise Endurance .....	15
【Table 2.12】	Temperature, Humidity .....	16
【Table 2.13】	Other Usage Conditions .....	16
【Table 3.1】	Relay Time Characteristics and Characteristic Values for Curve Selection .....	17
【Table 4.1】	Metering .....	21
【Table 4.2】	Communication Method .....	21
【Table 5.1】	Key Pad & Communication Connector .....	25
【Table 5.2】	LED ( Operating Indicators ) .....	25
【Table 6.1】	Time OCR Menu .....	30
【Table 6.2】	INST. OCR Menu .....	31
【Table 6.3】	Time OCGR Menu .....	31
【Table 6.4】	INST. OCGR Menu .....	32
【Table 6.5】	RS-485 Comm. Setting .....	33
【Table 6.6】	T/S Connection Menus .....	36
【Table 6.7】	Setting Menus .....	41
【Table 7.1】	SetGDRSeries Program Menus .....	43
【Table 7.2】	Communication Port Configuration .....	45
Appendix 1.	Product Factory Default Setting Values .....	50

## Order of Figures and Diagrams

【Figure 3.1】 INST.OCR(IOCGR) Logic Diagram .....	18
【Figure 3.2】 Time OCR(TOCR) Logic Diagram .....	19
【Figure 3.3】 INST.OCGR(IOCGR) Logic Diagram .....	20
【Figure 3.4】 Time OCGR(OCGR) Logic Diagram .....	20
【Figure 4.1】 RS-232C Circuit Diagram .....	22
【Figure 4.2】 RS-232C Connection .....	22
【Figure 4.3】 RS-485C Line Connection Diagram .....	22
【Figure 5.1】 Front Panel Display .....	24
【Figure 6.1】 Menu Tree .....	27
【Figure 7.1】 SetGDRSeries Default Screen .....	42
【Figure 7.2】 Relay Selecting .....	44
【Figure 7.3】 Communication Port Setting .....	44
【Figure 7.4】 GDR-AB01 Setting .....	46
【Figure 7.5】 GDR-AB01 Status .....	47
【Figure 7.6】 GDR-AB01 Report .....	48
【Figure 7.7】 Help .....	49
Appended 1. Dimensioned Drawings - Unit : mm .....	51
Appended 2. Internal Block Diagram .....	52
Appended 3. External Connection Diagram .....	52
Appended 4. Inverse Time Characteristic Curve .....	53
Appended 5. Very Inverse Time Characteristic Curve .....	54
Appended 6. Extremely Inverse Time Characteristic Curve .....	55
Appended 7. Long Inverse Time Characteristic Curve .....	56
Appended 8. Kyongbo Induction Type Inverse Time(KEPCO Type) Characteristic Curve .....	57
Appended 9. Kyongbo Induction Type Very Inverse Time(KEPCO Type) Characteristic Curve .....	58
Appended 10. Definite Time Characteristic Curve .....	59



## 1. General Features

This Relay contains Relay elements of OCRx3 and OCGRx1 at the same time, and is a Digital arithmetic relay designed and manufactured properly for the protection against Short Circuit, Overload, and Ground Accident, so it is not just easy to change the operation time and operation current, but it can also record and store fault information thereby greatly enhancing the reliability of the cable line, and the main characteristics are as follows.

### Features

- Total arithmetic type over-current Relay.
- Variety of timing characteristics(7 timing characteristics enclosed)
- Duration of maintaining output contact is 0.00 ~ 60.00Sec (0.01Sec Step), and variable setting is possible.
- Set value and measured values are Displayed digitally through LCD Screen. (4 x 20 LCD Screen)
- Enhance reliability with surveillance function at all times.
- Free selection of frequency Settings according to the rated frequency of the line. (50 / 60Hz)
- Possible to set each of 7 Relay contact output (T/S Output) to 19 modes, and all of these can be used for Alarms.
  - contact for Trip(1a), contact for Signal(6a)
- Reliability is increased by the operation through output contacts when the Relay is in abnormal state.
- Convenient PC Applications
  - SetGDRSeries : change setting values, verify the measurements, verify Fault information, display status, Remote Reset.
- Possible to self-test through manual Trip command(Contact Test)
- Maintains thorough security using password input when changing setting values
- Various communications supported
  - Communication Methods : RS-232C, RS-485C (SCADA communications)
  - Supported Protocol : MODBUS
- Increased EMC / EMI performance
- Applied Standard : Korea Electrical Manufacturers' Cooperative Standard (KEMC1120)

## 2. Technical Data

### 2.1 Current Input

**【Table 2.1】 Input Current**

<b>Rated Current (IN)</b>	AC 5A
<b>Overload Endurance</b>	2 times rated current / 3 hours 20 times rated current / 2 seconds
<b>Burden</b>	0.5VA or less

### 2.2 Rated Control Source Voltage

**【Table 2.2】 Rated Control Source Voltage**

<b>Rated Control Source Voltage</b>	AC/DC 110 ~ 220V (free voltage)	
<b>Overload Endurance</b>	1.3 times rated voltage / 3 hours	
<b>Burden</b>	Always	30W or less
	Operation	70W or less

### 2.3 Rated Frequency

50Hz or 60Hz (Sine Waveform)

### 2.4 Case

**【Table 2.3】 Case**

<b>Case Structure</b>	Flushed Drawer Type
<b>Case Color</b>	Munsell No. N1.5 (Black)
<b>Case Material</b>	Fe (Steel)

## 2.5 Time Overcurrent

**【Table 2.4】 Time Overcurrent Element**

<b>Operation Value</b>	2.0 ~ 12.5A (0.1A Step)
<b>Operation Time Characteristics</b>	Inverse Time , Very Inverse Time , Extreme Inverse Time , Long Inverse Time Kyongbo Induction Type (KEPCO Type) Inverse Time , Kyongbo Induction Type (KEPCO Type) Very Inverse Time , Definite Time
<b>Operation Time Ratio</b>	0.1 ~ 10.0 (0.1 Step)
<b>Definite Time Operation Time</b>	0.04 ~ 60.00Sec (0.01Sec Step)
<b>Release Delay Time</b>	0.00 ~ 60.00Sec (0.01Sec Step)
<b>Release Value</b>	At least 95% of the Setting Value
<b>Operation Value Precision Ratio</b>	Within $\pm 5\%$ of the Setting Value

## 2.6 Instantaneous Overcurrent

**【Table 2.5】 Instantaneous Overcurrent Element**

<b>Operation Value</b>	10 ~ 90A (1A Step)
<b>Operation Time Characteristics</b>	Instantaneous Time ( $\leq 40\text{ms}$ ), Definite Time
<b>Definite Time Operation Time</b>	0.04 ~ 60.00Sec (0.01Sec Step)
<b>Release Delay Time</b>	0.00 ~ 60.00Sec (0.01Sec Step)
<b>Release Value</b>	At least 95% of the Setting Value
<b>Operation Value Precision Ratio</b>	Within $\pm 5\%$ of the Setting Value

## 2.7 Time Ground Overcurrent

**【Table 2.6】 Time Ground Overcurrent Element**

<b>Operation Value</b>	0.2 ~ 2.5A (0.1A Step)
<b>Operation Time Characteristics</b>	Inverse Time , Very Inverse Time , Extreme Inverse Time , Long Inverse Time Kyongbo Induction Type (KEPCO Type) Inverse Time , Kyongbo Induction Type (KEPCO Type) Very Inverse Time , Definite Time
<b>Operation Time Ratio</b>	0.1 ~ 10.0 (0.1 Step)
<b>Definite Time Operation Time</b>	0.04 ~ 60.00Sec (0.01Sec Step)
<b>Release Delay Time</b>	0.00 ~ 60.00Sec (0.01Sec Step)
<b>Release Value</b>	At least 95% of the Setting Value
<b>Operation Value Precision Ratio</b>	Within $\pm 5\%$ of the Setting Value

## 2.8 Instantaneous Ground Overcurrent

**【Table 2.7】 Instantaneous Ground Overcurrent Element**

<b>Operation Value</b>	2 ~ 50A (1A Step)
<b>Operation Time Characteristics</b>	Instantaneous Time ( $\leq 40\text{ms}$ ), Definite Time
<b>Definite Time Operation Time</b>	0.04 ~ 60.00Sec (0.01Sec Step)
<b>Release Delay Time</b>	0.00 ~ 60.00Sec (0.01Sec Step)
<b>Release Value</b>	At least 95% of the Setting Value
<b>Operation Value Precision Ratio</b>	Within $\pm 5\%$ of the Setting Value

## 2.9 Output Contacts

**[Table 2.8] Output Contacts / Capacity**

<b>T / S1 contacts (Trip contacts) - 1a Contact</b>	
<b>Rated Power</b>	AC 250V, DC 125V
<b>Continuous Flow Electricity Capacity</b>	20A (AC 250V)
<b>0.5 sec. Close Circuit Capacity</b>	30A (DC 125V)
<b>Closing Capacity</b>	6250VA
<b>Material</b>	Silver alloy
<b>T / S2 ~ T / S7 Contacts (Signal contacts) - 6a Contact</b>	
<b>Rated Power</b>	AC 250V, DC 125V
<b>Continuous Flow Electricity Capacity</b>	5A (AC 250V)
<b>0.5 sec. Close Circuit Capacity</b>	5A (DC 125V)
<b>Closing Capacity</b>	1250VA / 150W
<b>Material</b>	Gold-plate silver alloy
<b>Healthy Alarm - 1b Contact</b>	
<b>Rated Power</b>	AC 250V, DC 125V
<b>Continuous Flow Electricity Capacity</b>	10A (AC 250V)
<b>Open Circuit Capacity</b>	DC 125V, 30W, Time constant(25ms), 1A
<b>Closing Capacity</b>	2500VA / 300W
<b>Material</b>	Silver alloy

## 2.10 Insulation Test

**【Table 2.9】 Insulation**

<b>Insulation Resistance</b>	DC 500V	Electric Circuit to Ground	10MΩ	IEC60255-5
		Between Electric Circuits	5MΩ	
		Between Electric Circuit Connections		
<b>Commercial Frequency Withstand Voltage</b>	50/60Hz, 1min	Electric Circuit Bundle to Ground	2kV	IEC60255-5
		Between Electric Circuits		
		Between Connection Circuit Contacts	1kV	
<b>Impulse Withstand Voltage</b>	1.2/50μs, 3 times each for positive/negative polarity	Electric Circuit Bundle to Ground	5kV	IEC60255-5
		Between Transformer Circuits		
		Between Transformer Control Circuits		
		Between Control Circuits	3kV	
		Between Tranformer Circuit Contacts		
		Between Control Power Circuit Contacts		

Caution) AUX POWER and 485 Communication Circuits enclose surge protection circuit inside the relay, so do not test insulation resistance test and withstand voltage test.

## 2.11 Mechanical Test

**【Table 2.10】 Vibration, Shock, Earthquake**

<b>Vibration</b>	<b>Vibration Response Test</b>	10 ~ 150Hz, 0.5G, Front/Back, Left/Right, Up/Down 1 time
	<b>Vibration Endurance Test</b>	10 ~ 150Hz, 1G, Front/Back, Left/Right, Up/Down 20 times
<b>Shock</b>	<b>Shock Response Test</b>	5G, Front/Back, Left/Right, Up/Down 3 times
	<b>Shock Withstand Test</b>	15G, Front/Back, Left/Right, Up/Down 3 times
	<b>Bump Test</b>	10G, Front/Back, Left/Right, Up/Down 100 times
<b>Earthquake</b>	<b>1 ~ 8Hz</b>	x : 3.5mm, y : 1.5mm, Sweep : 1 time
	<b>8 ~ 35Hz</b>	x : 1g, y : 0.5g, Sweep : 1 time

## 2.12 Noise Test

**【Table 2.11】 Noise Endurance**

<b>1MHz burst disturbance</b>	1MHz, 75ns, 400Hz, 2Sec	Common mode	2.5kV	IEC60255-22-1
		Differential mode	1.0kV	
<b>EFT Burst</b>	Applied Voltage	4kV		IEC60255-22-4
	Repeated Frequency	2.5kHz		
<b>Electrostatic Discharge</b>	Air discharge	8kV		IEC60255-22-2
	Contact discharge	6kV		
<b>Surge Electrical Disturbance</b>	1.2/50 $\mu$ s, 8/20 $\mu$ s, 30sec, 3 times	Common mode	2.0kV	IEC60255-22-5
		Differential mode	1.0kV	
<b>Radio Frequency Radiation Endurance</b>	80MHz ~ 1GHz, 10V/m, 1sec			IEC60255-22-3
<b>Radio Frequency Conduction Endurance</b>	150kHz ~ 80MHz, 10V/m, 1sec			IEC60255-22-6

## 2.13 Temperature, Humidity Test

**【Table 2.12】 Temperature, Humidity**

<b>Temperature Range</b>	Operation Assurance	-10℃ ~ +55℃
	Recovery Assurance	-20℃ ~ +60℃
<b>Relative Humidity</b>		Daily Average 30% ~ 90%

## 2.14 Other Operating Condition

**【Table 2.13】 Other Operating Conditions**

<b>Surface Height</b>	1000m or less
Condition where there is no abnormal vibration, shock, slope or influence of the magnetic field	
Place where there is no explosive dust, flammable dust, or flammable / rusty gas, or salt	



### 3. Protection Characteristics

#### 3.1 Overcurrent Function

This relay contains the Instantaneous Time characteristic, Inverse Time characteristic, and Definite Time characteristic to be used for single phase, 2-phase, and 3-phase overcurrent and short circuit protection. GDR-AB01 marks the instantaneous element as INST.OCR(IOCR), and the definite time as Time OCR(TOCR).

The instantaneous time characteristic is a function to output Trip signal immediately when a current over the setting value is input, the Trip time is less than 40ms, and the inverse time characteristic is a function between the current and the time, and the operation time is shorter as the current is bigger. There are 4 international standard(IEC) inverse time characteristics and 2 KEPCO type inverse time characteristics equipped.

When applying the inverse time characteristics, select one from the 6 characteristics.

4 Inverse characteristics following the international standard(IEC255-4), and the time and current relationship function of 2 KEPCO type characteristics are as follows.

$$T = \left( \frac{K}{I^L - 1} + C \right) \times \frac{M}{10} (\text{sec})$$

T = Operation Time, K and C = Relay characteristic value

I = Relay input current / Relay operation setting value

L = Characteristic curve index, M = Operation time ratio

**【Table 3.14】 Relay Time Characteristics and Characteristic Values for Curve Selection**

Time Characteristic	Characteristic Value			Indication Mark	Note
	K	L	C		
Inverse Time	0.14	0.02	0	NI	-
Kyongbo Induction Type Inverse Time	0.11	0.02	0.42	KNI	KEPCO Type
Very Inverse Time	13.5	1	0	VI	-
Kyongbo Induction Type Very Inverse Time	39.85	1.95	1.084	KVI	KEPCO Type
Extreme Inverse Time	80	2	0	EI	-
Long Inverse Time	54	1	0	LI	-
Definite Time	-	-	-	DT	-

When setting the relay, selecting the time characteristic curve will decide the K, L, C values in the above table.

Logic Diagram for 3-phase overcurrent element operation is as follows.

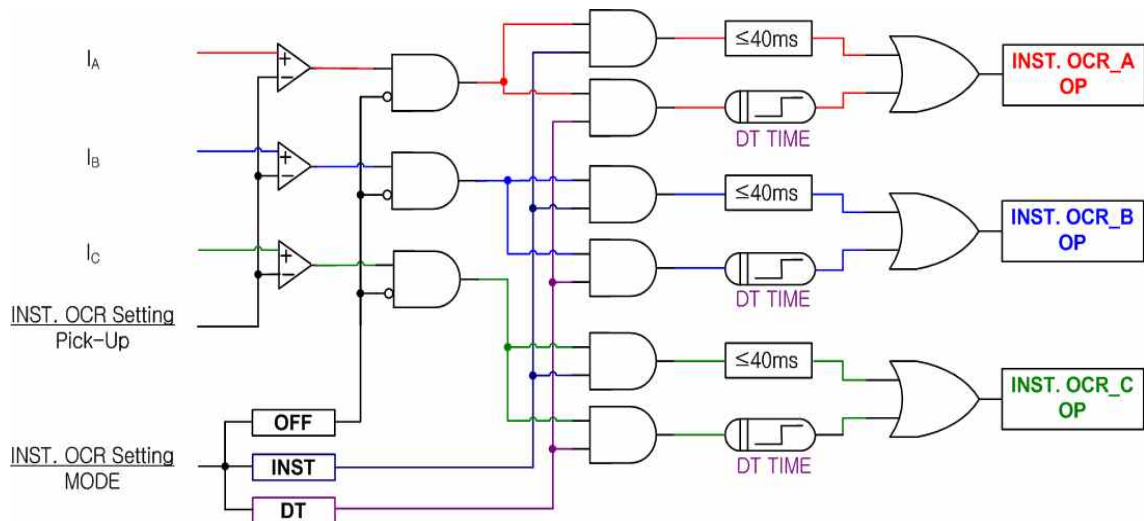

**【Figure 3.1】 INST.OCR(IOCR) Logic Diagram**

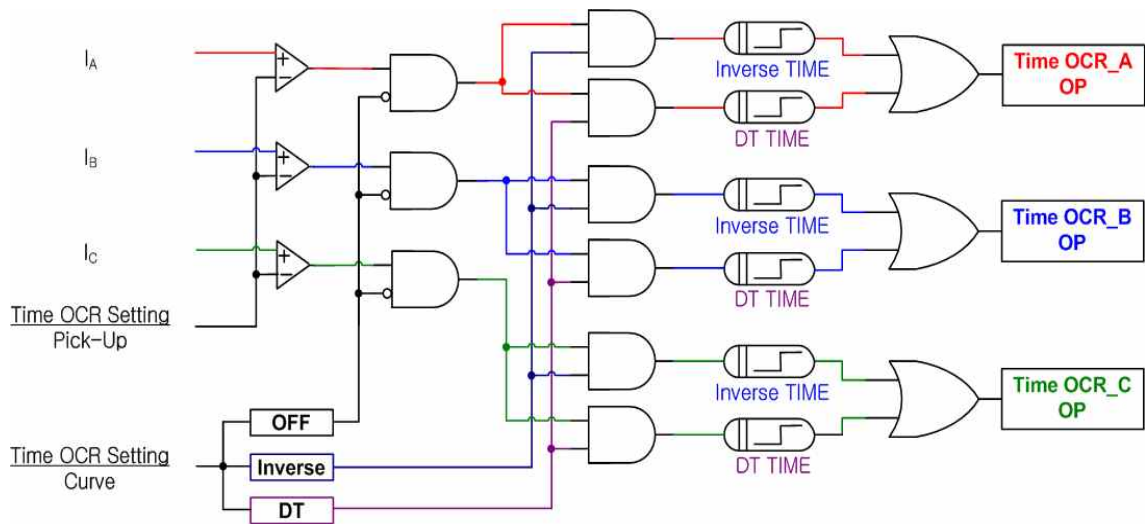

**【Figure 3.2】 Time OCR(TOCR) Logic Diagram**

### 3.2 Ground Overcurrent Function

It has the same fundamental and characteristic with 3-Phase overcurrent relay function, and the only differences are that it receives the ground current signal input and the setting range is smaller than 3-phase overcurrent.

There are also instantaneous element and time element in the ground overcurrent relay function, instantaneous element is marked as INST. OCGR(IOCGR), and time element is marked as Time OCGR(TOCGR).

Logic Diagram for ground overcurrent element operation is as follows.

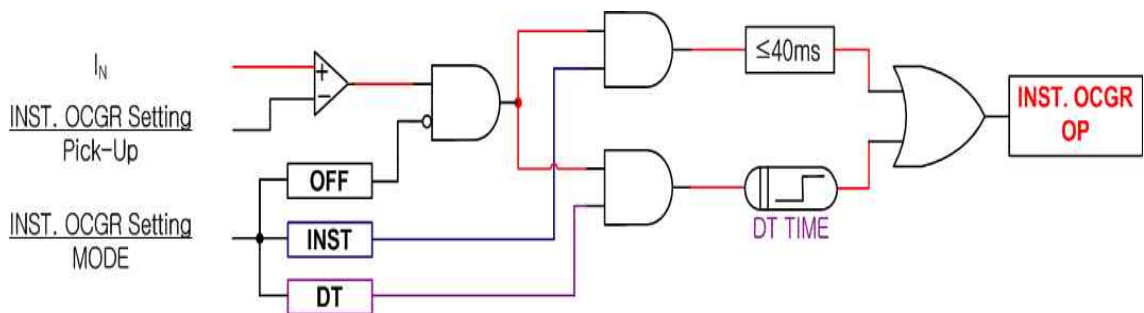

**[Figure 3.3] INST.OCGR(IOCGR) Logic Diagram**

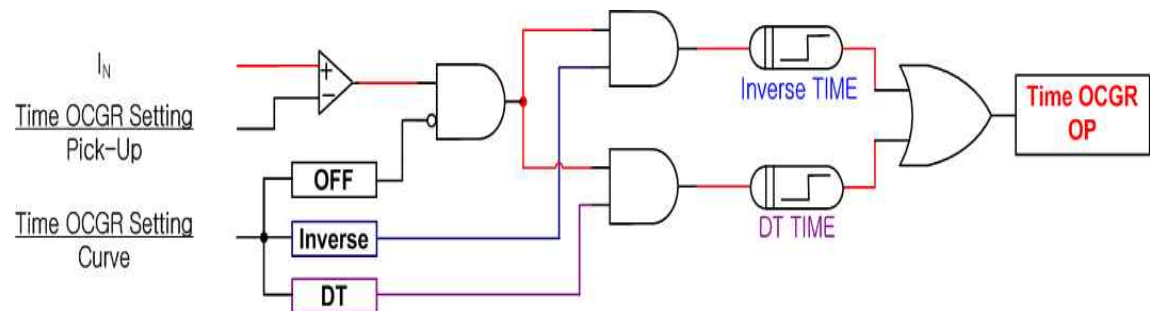

**[Figure 3.4] Time OCGR(TOCGR) Logic Diagram**

## 4. Subsidiary Function

### 4.1 Metering

This relay has the metering function of the 3-phase and ground current.

**【Table 4.1】 Metering Display**

Category	Characteristic
<b>I<sub>a</sub>, I<sub>b</sub>, I<sub>c</sub> phase Current</b>	<ul style="list-style-type: none"> <li>● Measure the effective value of the Current</li> <li>● 1st Current of the relay input current converted by CT ratio</li> <li>● Metering Range : 0 ~ 200A (When Phase CT Ratio is 5:5)</li> </ul>
<b>Ground Current(I<sub>N</sub>)</b>	<ul style="list-style-type: none"> <li>● Measure the effective value of the Current</li> <li>● 1st Current of the relay input current converted by CT ratio</li> <li>● Metering Range : 0 ~ 100A (When Ground CT Ratio is 5:5)</li> </ul>

Except, the current over the metering range is displayed as FULL.

### 4.2 Communication

This relay offers the general purpose RS-232C / RS-485C communication method, and the maximum speed of 19200 bps data transmission is possible. There are 1 RS-232C port in the front and 1 RS-485C port in the back of the relay. The RS-232C communication port in the front of the relay is connected to PC and used for changing the setting values, viewing the measurement, verifying Fault information, display the status, and Remote Reset, and the RS-485C communication port in the back is used for remote SCADA communication.

**【Table 4.2】 Communication Method**

<b>Protocol</b>	<b>Communication Method</b>	● RS-232/485
	<b>Supported Protocol</b>	● MODBUS
<b>Communication Protocol (RS-485C)</b>	<b>Communication Distance</b>	● 1.2km
	<b>Communication Cable</b>	● General RS-485C Two-Pair cable
	<b>Communication Speed</b>	● 300 ~19200 bps
	<b>Communication Method</b>	● Half-Duplex
	<b>Maximum In/Out Voltage</b>	● -7V ~ +12V
<b>Communication Port</b>	<b>Front Display Panel</b>	<ul style="list-style-type: none"> <li>● RS232 Port 1</li> <li>● 19200 BPS, MODBUS Protocol</li> </ul>
	<b>Back</b>	<ul style="list-style-type: none"> <li>● RS485 Port 1</li> <li>● 300 ~ 19200 BPS, MODBUS Protocol</li> <li>● SCADA Communication</li> <li>● Contact No. : 13(+), 15(-)</li> </ul>

### 4.2.1 RS-232C Communication

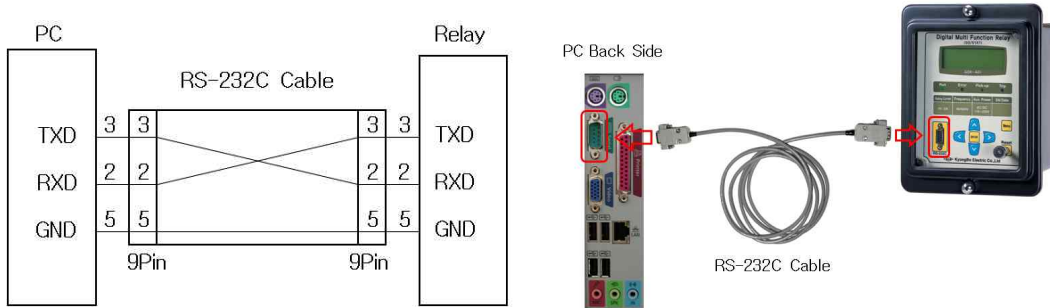

**【Figure 4.1】 RS-232C Circuit Diagram      【Figure 4.2】 RS-232C Connection**

- The RS-232C communication cable supplied with this product uses a cross cable which has No. 2 and No. 3 pins crossed as shown in **【Figure 4.1】**, so using ordinary direct cable will not enable the communication.
- If there is no RS-232C port in the PC, and uses USB port, only with USB to 232 cable cannot make connection, so please use USB to 232 cable with the cross cable supplied with this product together.

### 4.2.2 RS-485C Communication

To connect to higher level monitoring control system, insulated RS-485 Half Duplex communication method is provided. This communication method can connect with multi-drop, and the maximum communication distance is 1.2km. The end part of RS-485C cable should be connected with 120Ω resistor parallel as shown in the following figure.

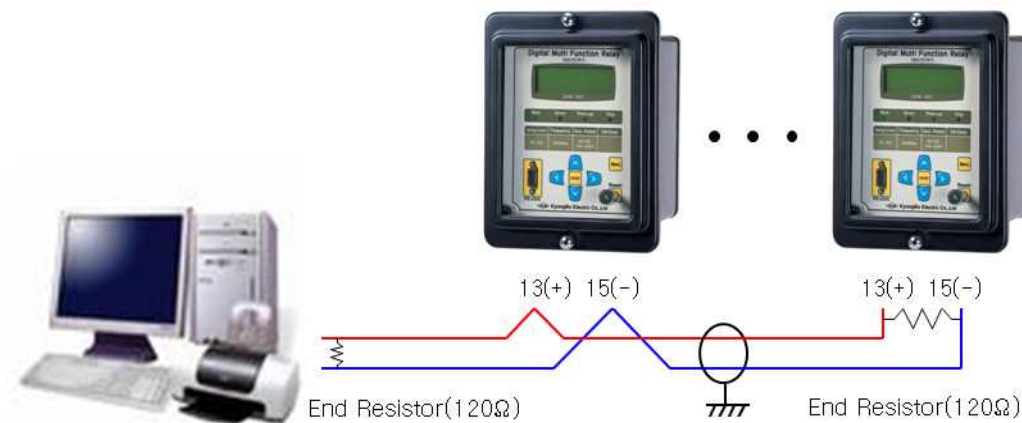

**【Figure 4.3】 RS-485C Connection Diagram**

### 4.3 Self Diagnosis Function

Self Diagnosis function monitors the operation status of the relay at all times to prevent abnormal/failure operation of the equipment. If an abnormality is detected, red Error LED is lighted, and the Self Diagnosis result category in the Self-Diagnosis menu is displayed as FAIL. Also, when a fault occurs, the operation output of the relay element is blocked immediately, and it is displayed on LCD and LED until the fault is cleared.

Main diagnosis categories are as follows.

- Power Fail
- CPU Watchdog Fail
- Memory Fail
- Value outside Setting

### 4.4 Fault Recording Function

This function displays the accumulated count of operation, current, operation element, and relay operation time.

It can be viewed using PC Tool(SetGDRSeries) through RS-232C communication.

## 5. Display Panel Construction

### 5.1 Front-side Display Panel Structure

The front-side display panel has 20 x 4 LCD, 4 LEDs, 7 KeyPad, and RS-232C Communication Connector as follows. There is a transparent cover on the front-side to prevent dust or foreign substance from entering and to stop unnecessary key operations. When changing the setting value, it is required to input password to prevent unauthorized user other than designated person to change the setting, and the protection function is still operational during the inquiry through LCD.

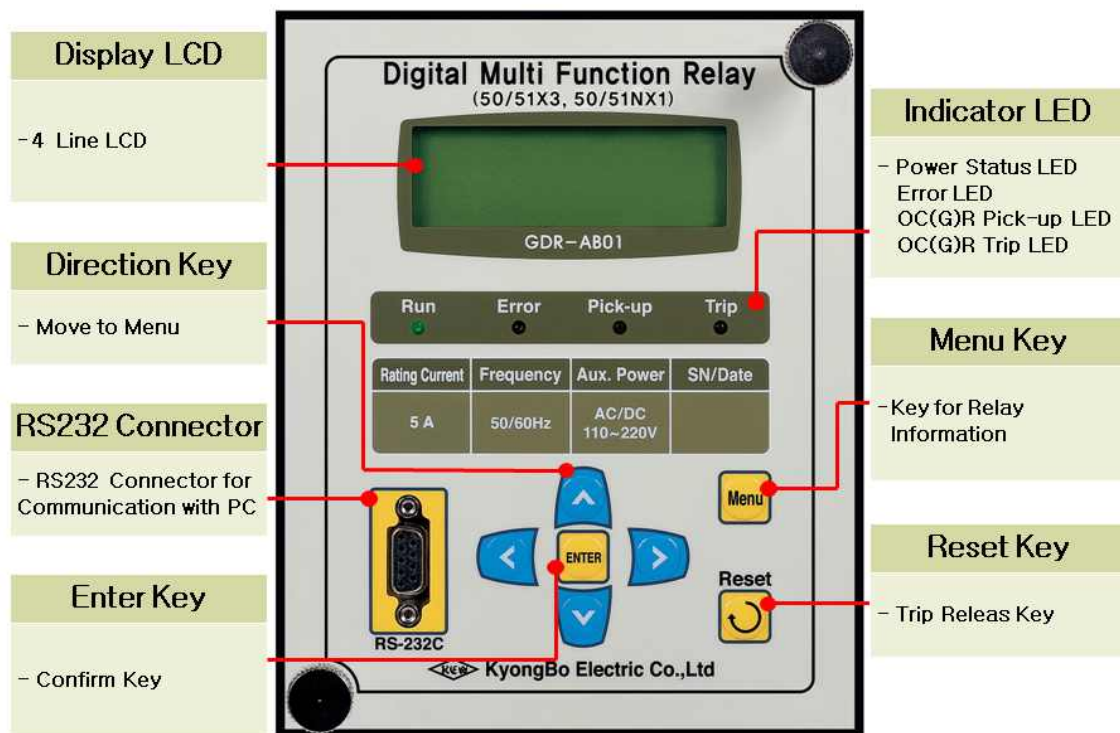







**【Figure 5.1】** Front-side Display



## 5.2 Key Pad & Communication Connector

**【Table 5.1】 Key Pad & Communication Connector**

<b>Direction</b> (     ) <b>Key</b>	Used for setting value changes and moving between menus.
<b>ENTER</b> (  ) <b>Key</b>	Key used to confirm changes in menu or setting.
<b>Reset</b> (  ) <b>Key</b>	Key used for Indicator Reset when the relay is in operation, and to verify the settings without opening the cover when a fault has not occurred.
<b>Menu</b> (  ) <b>Key</b>	Key to verify and change all the information such as setting values and fault record.
<b>RS-232C Connector</b>	RS-232C Connector enabling setting value changes from PC with mutual communication with PC.

## 5.3 LED ( Operating Indicators )

**【Table 5.2】 LED ( Operating Indicators )**

<b>Run</b> ( <b>Green</b> )	As a LED indicating that the power is supplied and the CPU of the protection relay is running normally, it is lighted in normal condition, and if it is not lighted when the power is supplied, it means the CPU is not running, and there is a serious problem in the equipment, so it requires repair or replacement.
<b>Error</b> ( <b>Red</b> )	When there is a fault in the equipment and the fault is detected by the self-diagnosis function, Error LED is lighted red, and the protection relay element operation is blocked. The details of the fault can be viewed through LCD with Key operation, and when the fault is cleared, it is recovered with the lighted LED turning off.
<b>Pick-up</b> ( <b>Yellow</b> )	When the OCR and OCGR element are Picked Up by matching the set condition, Pick-Up LED is lighted yellow, and it is turned off automatically when it is recovered.
<b>Trip</b> ( <b>Red</b> )	As an operation indicator of OCR and OCGR element, when the element operates, it outputs Trip and Trip LED is lighted red at the same time. Even if the protection element is recovered, the lighted LED at this state is kept on until Reset (  ) Key is pressed.

## 6. Display & Setting Modes

### 6.1 Key Operation and LCD Construction

#### 6.1.1 LCD Initial Display Status, Backlight On/Off



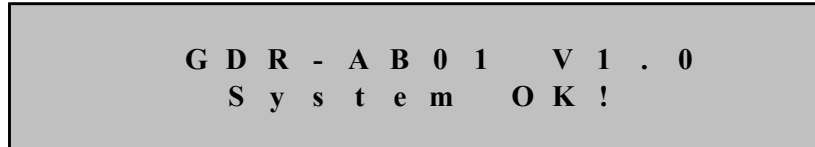

After the power is ON, the follow default screen is displayed.





If there is a fault in the equipment, System Error! is displayed instead of System OK!

The LCD Backlight is turned Off automatically after 3 minutes has passed without Key operation.

#### 6.1.2 LCD Screen Display and the Principles of Key Operation

The information Displayed on LCD Screen is made of a Tree structure, and you can find and select the information in the Tree structure using Left(  ), Right(  ), Up(  ), Down(  ) Keys.

The category that the cursor( \* ) is pointing indicates the current selected category, and pressing  Key will Display detail categories. To exit the current category, press .

#### 6.1.3 One-button Display

You can view the measured values, setting values, and diagnosis status sequentially on LCD Screen by pressing Reset (  ) Key repeatedly. This enables viewing without opening the transparent cover on the front part of the Relay.

When Operating Indicator is turned on as the Relay element is operational, it operates as Indicator Reset.

#### 6.1.4 Menu-Tree

【Figure 6.1】 Menu Tree summarized the menu structure that can be Displayed on the Relay.

Operations and descriptions of each menu are stated in detail in 6.2 Setting Modes.

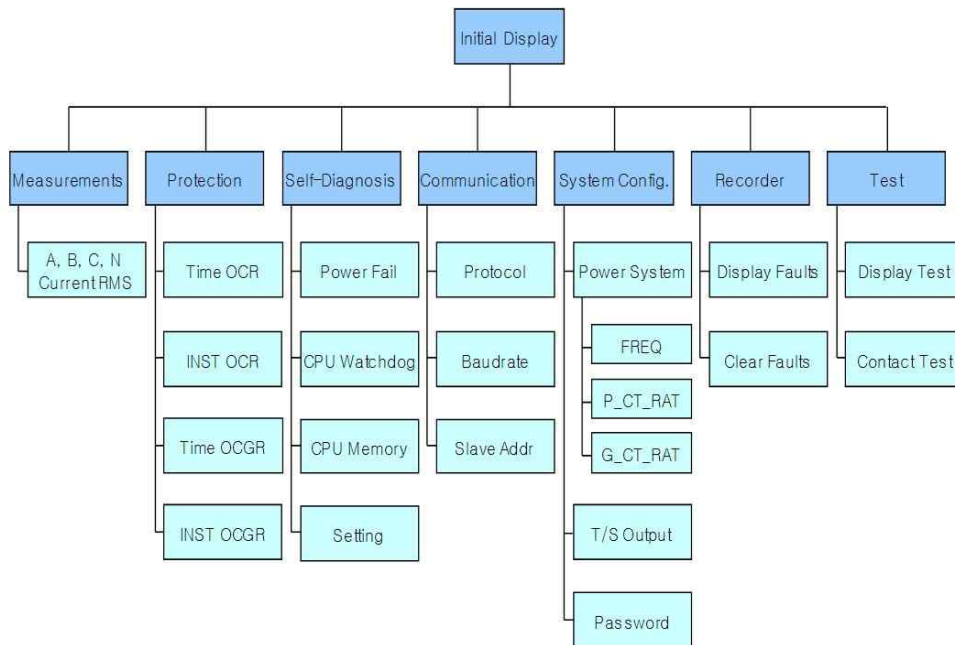



**【Figure 6.1】 Menu Tree**

## 6.2 Setting Modes

For this Relay to operate properly, it needs to be set appropriately to the system environment in which it is used. The Settings and Display elements are composed of 7 categories of Measurement, Protection, Self-Diagnosis, RS-485 Comm., System Config, Recorder, and Test.

Press Menu (  ) Key from the default LCD screen, then the screen asking for Password appears.

E n t e r P a s s w o r d : \* \* \* \*

- (1)  Key : Changes the number
- (2)  Key : Changes the location of the digit
- (3) ENTER (  ) Key : Confirm the password after the input of password.

Password is composed of 4 digits from 0 ~ 9, and the default password of the relay is set to "0000", so pressing ENTER (  ) Key from the password input screen will convert directly to Setting screen.

The Setting default screen is as follows.

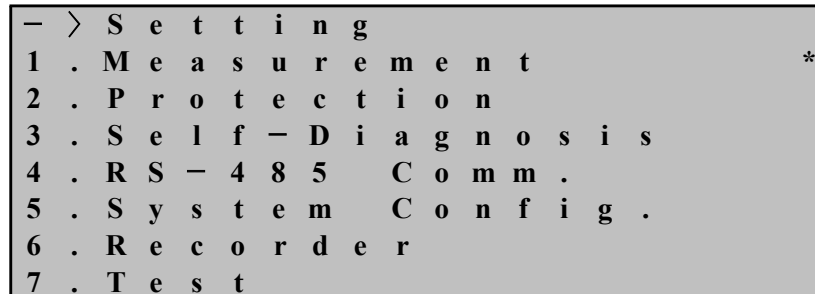

For example, to change PickUp current of the Instantaneous overcurrent, operate as the following order.

- (1) Press Key : ( \* ) symbol moves to 2.Protection category
- (2) Press Key : moves to Protection screen
- (3) Press Key : ( \* ) symbol moves to 2.INST. OCR category
- (4) Press Key : moves to INST. OCR Screen
- (5) Press Key : ( \* ) symbol moves to 2.PICK-UP category
- (6) Press Key : currently stored current value of 2.PICK-UP flashes.
- (7) Press Key : changes to desired setting value
- (8) Press ENTER ( ) Key : temporarily stores the decided value
- (9) Press Key : moves to Protection Screen
- (10) Press Key : moves Setting Screen
- (11) Press Key : displays the following screen. "No" category flashes.

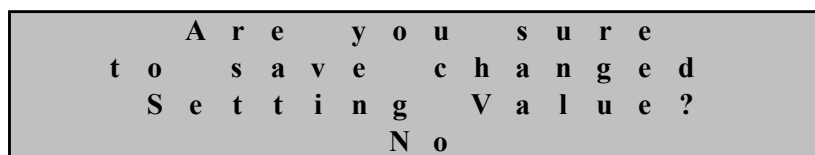

- (12) Press Key : select Yes from Yes and No categories
- (13) Press ENTER ( ) Key : stores the changed value and moves to the default screen

If selecting No in (12) and pressing ENTER ( ) Key will erase the changed value, and the original setting data is restored.

Also, until ENTER ( ) Key is pressed at "Are you sure to save changed Setting

Value? Yes", changed setting value does not affect the protection relay, and the original setting values are applied.

All the changes to each category can be done as of the above example.

### 6.2.1 Measurement Screen

Measurement Screen displays the measured current value.

Measurement Screen has the following category.

<b>I a :</b>	<b>2 . 5 0</b>	<b>A</b>
<b>I b :</b>	<b>2 . 4 5</b>	<b>A</b>
<b>I c :</b>	<b>3 . 5 5</b>	<b>A</b>
<b>I n :</b>	<b>1 . 4 5</b>	<b>A</b>

Display the current value for each phase (Display as CT 1st Side : 2nd Side Current multiplied by CT Ratio)

Pressing  Key in the Measurement Screen will exit this menu and convert to the upper menu.

### 6.2.2 Protection Setting

Protection Setting has categories to perform Time OCR, INST. OCR, Time OCGR, and INST. OCGR protection function.

Select 2. Protection category in Setting, and the following screen appears.

<b>- &gt;</b>	<b>P r o t e c t i o n</b>
<b>1 .</b>	<b>T i m e O C R</b>
<b>2 .</b>	<b>I N S T . O C R</b>
<b>3 .</b>	<b>T i m e O C G R</b>
<b>4 .</b>	<b>I N S T . O C G R</b>

Pressing  Key in the Protection Screen will exit this menu and convert to the default screen of Setting.

#### 6.2.2.1 Protection ► Time OCR Setting

It is a category to set the definite time overcurrent element, and selecting(  ) 1. Time OCR category in Protection will display the following screen.

```

- >   T i m e   O C R
1 . C U R V E           :           L I      *
2 . P I C K - U P      :           5 . 0 A
3 . T I M E   D I A L :           1 0 . 0
    
```

Press  Key in Time OCR screen, then it will exit this menu and convert to the upper menu.

Detail categories that can be set in Time OCR are as follows.

**[Table 6.1] Time OCR Menu**

Category	Range	Setting Unit	Default Value	Description
Curve	OFF, NI, VI, EI, LI, KNI, KVI, DT	-	KVI	Set definite time characteristic
PickUp	2.0 ~ 12.5A	0.1A	5.0A	Definite time Pickup value
Time Dial	0.1 ~ 10.0	0.1	10.0	Set time ratio
DT-Time	0.04 ~ 60.00Sec	0.01Sec	-	Set the time of definite time

### 6.2.2.2 Protection ► INST. OCR Setting

It is a category to set the instantaneous time overcurrent element, and selecting(  ) 2.INST. OCR category in Protection will display the following screen.

```

- >   I N S T .   O C R
1 . M O D E           :           D T      *
2 . P I C K - U P      :           5 0 A
3 . D T - T I M E      :           0 . 0 4 s
    
```

Press  Key in INST. OCR screen, then it will exit this menu and convert to the upper menu.

Detail categories that can be set in INST. OCR are as follows.

**【Table 6.2】 INST. OCR Menu**

Category	Range	Setting Unit	Default Value	Description
Mode	OFF, INST, DT	-	DT	Set OFF, instantaneous time, definite time
PickUp	10 ~ 90A	1A	50A	Instantaneous Pickup value
DT-Time	0.04 ~ 60.00Sec	0.01Sec	0.04Sec	Set the time of definite time

**6.2.2.3 Protection ▶ Time OCGR Setting**

It is a category to set the definite time overcurrent element, and selecting(  ) 1. Time OCGR category in Protection will display the following screen.

- >	T i m e	O C G R		
1 .	C U R V E	:	N I	*
2 .	P I C K - U P	:	0 . 1 A	
3 .	T I M E D I A L	:	1 0 . 0	

Press  Key in Time OCGR screen, then it will exit this menu and convert to the upper menu.

Detail categories that can be set in Time OCGR are as follows.

**【Table 6.3】 Time OCGR Menu**

Category	Range	Setting Unit	Default Value	Description
Curve	OFF, NI, VI, EI, LI, KNI, KVI, DT	-	KVI	Set definite time characteristic
PickUp	0.2 ~ 2.5A	0.1A	5.0A	Definite time Pickup value
Time Dial	0.1 ~ 10.0	0.1	10.0	Set time ratio
DT-Time	0.04 ~ 60.00Sec	0.01Sec	-	Set the time of definite time

**6.2.2.4 Protection ▶ INST. OCGR Setting**

It is a category to set the instantaneous time overcurrent element, and selecting(  ) 2.INST. OCGR category in Protection will display the following screen.

- > I N S T . O C G R				
1 .	M O D E	:	D T	*
2 .	P I C K - U P	:	1 0 A	
3 .	D T - T I M E	:	0 . 0 4 s	

Press  Key in INST. OCGR screen, then it will exit this menu and convert to the upper menu.

Detail categories that can be set in INST. OCGR are as follows.

**[Table 6.4] INST. OCGR Menu**

Category	Range	Setting Unit	Default Value	Description
Mode	OFF, INST, DT	-	DT	Set OFF, instantaneous time, definite time
PickUp	2 ~ 50A	1A	5A	Instantaneous Pickup value
DT-Time	0.04 ~ 60.00Sec	0.01Sec	0.04Sec	Set the time of definite time

### 6.2.3 Self-Diagnosis Screen

This menu displays the result of the self-diagnosis function for each diagnosis category.

Diagnosis categories are control power, CPU WatchDog Timer, memory, and setting value, and if a fault occurs for each category, "FAIL" is displayed, and "System Error!" is displayed in the default LCD screen instead of "System OK!", and Error LED is lighted red.

Self-Diagnosis Screen is as follows.

1 .	P o w e r F a i l	:	F A I L	*
2 .	C P U W a t c h d o g	:	O K	
3 .	M e m o r y	:	O K	
4 .	S e t t i n g	:	O K	

Press  Key in self-diagnosis screen, then it will exit this menu and convert to the upper menu.

### 6.2.4 RS-485 Comm. Setting

It is a category to set the communication setting, and it can set Baudrate and



Slave Addr.

Selecting(  ) 4. RS-485 Comm. category in Setting will display the following screen.

```

- >   R S - 4 8 5   C o m m .
1 . P r o t o c o l   : M o d B u s *
2 . B a u d r a t e   : 1 9 2 0 0
3 . S l a v e   A d d r :           1
    
```

Press  Key in RS-485 Comm. screen, then it will exit this menu and convert to the upper menu.

**【Table 6.5】 RS-485 Comm. Setting**

Category	Range	Default Value	Description
Protocol	MODBUS	MODBUS	Communication Protocol
Baudrate	300, 600, 1200, 2400, 4800, 9600, 19200 (bps)	19200	Set the communication speed
Slave Addr	1~254	1	Set Slave Addr

### 6.2.5 System Config. Setting

System Config. has detail categories of Power system, T/S Output, and Password. Selecting(  )5. System Config. category in Setting will display the following screen.

```

- >   S y s t e m   C o n f i g .
1 . P o w e r   S y s t e m           *
2 . T / S   O u t p u t
3 . P a s s w o r d
    
```

Press  Key in System Config. screen, then it will exit this menu and convert to the default screen of Setting.

#### 6.2.5.1 System Config. ► Power system Setting

Power system has detail categories of FREQ(frequency), P\_CT\_RAT, and G\_CT\_RAT.

Selecting(  ) 1. Power system category in System Config. will display the following screen.

- >	P o w e r	S y s t e m	
1 .	F R E Q	:	6 0 H z *
2 .	P _ C T _ R A T	:	5 : 5
3 .	G _ C T _ R A T	:	5 : 5

Press  Key in Power system screen, then it will exit this menu and convert to the upper menu.

- **System Config. ▶ Power system ▶ FREQ Setting**

It is a category to set the common frequency used in the system where the relay is used.

There are two categories, 50Hz and 60Hz, and for cable using 60Hz, select 60Hz.

- **System Config. ▶ Power system ▶ P\_CT\_RAT Setting**

It is a category to set the 1st CT ratio on Phase side. It can be set in 5 units from 5 to 10000. This relay is designed for CT 2nd rated to be 5A, so CT with 5A 2nd must be selected when selecting CT. For example, if using CT of Phase side as 1000:5, set 1000 in P\_CT\_RAT setting.

- **System Config. ▶ Power system ▶ G\_CT\_RAT Setting**



It is a category to set the 1st CT ratio on Phase side. It can be set in 5 units from 5 to 10000. This relay is designed for CT 2nd rated to be 5A, so CT with 5A 2nd must be selected when selecting CT. For example, if using CT of Ground side as 2000:5, set 2000 in G\_CT\_RAT setting.

### 6.2.5.2 System Config. ▶ T/S Output Setting

Connection types and recovery delay time for 7 output connections can be set in T/S Output.

Select 2. T/S Output category in System Config., then the following screen appears.

- >	T / S	O u t p u t	
1 .	T / S 1		*
2 .	T / S 2		
3 .	T / S 3		
4 .	T / S 4		
5 .	T / S 5		
6 .	T / S 6		
7 .	T / S 7		

To set the desired T/S, press ,  Key to move ( \* ) symbol to the desired category.

• **System Config. ▶ T/S Output ▶ T/S 1 Setting**

It is a category that can set the connection type, recovery method, and recovery delay time, etc. for 7 output connections in T/S Output.

Select 1. T/S 1 category in T/S Output, then the following screen appears.

- >	T / S	1	
1 .	C O N	:	P R O T _ O R *
2 .	R S T	:	S E L F
3 .	D L Y	:	0 . 0 0 s

T/S 1 in the above screen means No. 1 output connection.

Press  Key in T/S 1 screen, then it will exit this menu and convert to the upper menu.

• **System Config. ▶ T/S Output ▶ T/S 1 ▶ 1.CON Setting**

It is a category to select in which condition to operate the output connection.

The types and meanings to connect output connection are as follows.



**【Table 6.6】 T/S Connection Menus**

Connection	Description
OFF	Connection not used.
PROT_OR	Output if any one of the relay element is in operation among all elements.
IOCR_OR	Output if instantaneous overcurrent element is in operation.
IOCR_A	Output if instantaneous overcurrent element A phase is in operation.
IOCR_B	Output if instantaneous overcurrent element B phase is in operation.
IOCR_C	Output if instantaneous overcurrent element C phase is in operation.
TOCR_OR	Output if time overcurrent element is in operation.
TOCR_A	Output if time overcurrent element A phase is in operation.
TOCR_B	Output if time overcurrent element B phase is in operation.
TOCR_C	Output if time overcurrent element C phase is in operation.
OCR_A	Output if instantaneous and time overcurrent element A phase is in operation.
OCR_B	Output if instantaneous and time overcurrent element B phase is in operation.
OCR_C	Output if instantaneous and time overcurrent element C phase is in operation.
IOCGR	Output if instantaneous ground overcurrent element is in operation.
TOCGR	Output if time ground overcurrent element is in operation.
IOCR+TOCR	Output if any one of instantaneous overcurrent element and time overcurrent element is in operation.
IOCR+IOCGR	Output if any one of instantaneous overcurrent element and instantaneous ground overcurrent element is in operation.
TOCR+TOCGR	Output if any one of time overcurrent element and time ground overcurrent element is in operation.
IOCGR_TOCGR	Output if any one of instantaneous ground overcurrent element and time ground overcurrent element is in operation.

• **System Config. ▶ T/S Output ▶ T/S 1 ▶ 2.RST Setting**

It is a category to set which method should be used when the output connection is recovered after the operation.

This relay has two methods, Self Mode and Manual Mode.

Self Mode is a function that the relay is automatically recovered after the operation, and Manual Mode is a function that the relay is not automatically recovered, but manually recovered. That is, it is not recovered until the user presses Reset (  ) Key, and is recovered when the Reset (  ) Key is pressed.

• **System Config. ▶ T/S Output ▶ T/S 1 ▶ 3.DLY Setting**

It is a category that can add to the recovery delay time on the recovery.

This menu is only applied when it is in Self Mode in the above 2. RST Setting, and is not applied if it is in Manual Mode.

If DLY is set to 0.00, it recovers within 40ms, and if you want the recovery within 100ms, set it to be 0.06.

It can be set in the units of 0.01Sec from 0.00 to 60.00, and it recovers with the error ratio of ±35ms if under 100ms, and the error ratio of ±5% if 100ms or more.

**6.2.5.3 System Config. ▶ Password Setting**

It is a category to change the Password Setting, and the password is set as 4 digits using the numbers from 0 to 9.

Select 3.Password category in Config., then the following screen appears.

```

- > P a s s w o r d
  N e w P a s s w o r d : * * * *
    
```

From this screen, input new password, and press ENTER (  ) Key, then the screen to input password again appears as follows.

```

- > P a s s w o r d
  N e w P a s s w o r d : * * * *
  C f m . P a s s w o r d : * * * *
    
```

From this screen, input password again, and press ENTER (  ) Key, then the following screen appears, and it converts to the upper menu.

```

- > P a s s w o r d <
  N e w P a s s w o r d : * * * *
  C f m . P a s s w o r d : * * * *
  P a s s w o r d C o n f i r m e d
    
```

If you don't want to change password in Password Screen, press  Key, then it will exit from this menu and convert to the upper menu.

### 6.2.6 Recorder

Recorder category displays the fault content and the number of faults.

Select 6. Recorder in Setting, then the following screen appears.

```

- >   F a u l t   R e p o r t
1 . D i s p l a y   F a u l t s   *
2 . C l e a r   F a u l t
      1 9 0   F a u l t !
    
```

Press  Key in Test Screen, then it will exit this menu and convert to the default screen of Setting.



#### 6.2.6.1 Recorder ► 1.Display Fault Screen

Display Fault Screen displays the recent fault record. If a new fault occurs, the old record is erased and the new fault is stored.

Select 1.Display Fault category in Recorder, then the following screen appears.

```

- >   D i s p l a y   F a u l t s
1 . C o u n t e r   :   1 9 0   *
2 . E l e m e n t   :   T O C R _ B
3 . T i m e       :   1 . 5 4 s
4 . I a          :   2 0 . 2 7 A
5 . I b          :   2 0 . 1 5 A
6 . I c          :   2 0 . 1 7 A
7 . I n          :   2 0 . 8 3 A
    
```

To view fault record from the above screen, press ,  Key to view the detail categories such as accumulated number of operation, current, operating element, and relay operation time, etc.

Press Display  Key in Fault Screen, then it will exit this menu and convert to the upper menu.

#### 6.2.6.2 Recorder ► 2.Clear Fault Category

This category can delete the stored Fault content.

Select 2.Clear Fault in Recorder, then the following screen appears.

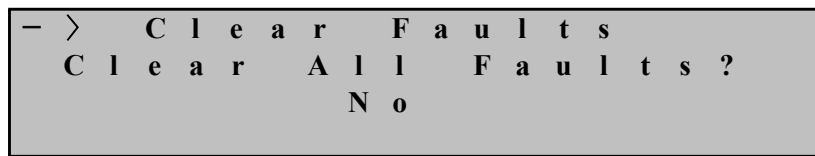

In the above screen, "No" flashes, and if you don't want to delete the fault record stored, press Key, and if you want to delete the fault record, press Key to change "No" to "Yes", and press ENTER ( ) Key.

### 6.2.7 Test

You can test Front Display(Panel), Connection Output, etc. in Test category. Select 7. Test in Setting, then the following screen appears.

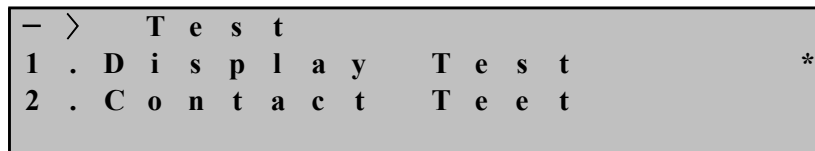

Press Key in Test Screen, then it will exit this menu and convert to the default screen of Setting.

#### 6.2.7.1 Test ► Display Test

This menu is a category that can check the condition of LCD and LED on the relay front side.

Select 1.Display Test in Test, then the following screen appears.

If you don't want the Display Test in the Display Test Screen, press Key, then it will exit this menu and convert to the upper menu.

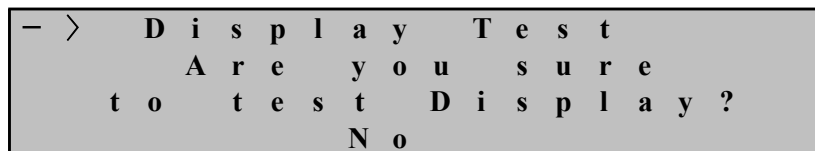

To perform Display Test, press Key from this screen to change "No" to "Yes", and press ENTER ( ) Key, then TEST will flash 3 times on LCD, and all the LEDs flashes 3 times at the same time, then it will move to Test menu.

When performing Display Test, the following screen appears.

```

T E S T T E S T T E S T T E S T T E S T
T E S T T E S T T E S T T E S T T E S T
T E S T T E S T T E S T T E S T T E S T
T E S T T E S T T E S T T E S T T E S T
    
```

### 6.2.7.2 Test ▶ Contact Test

This menu is a category that can check the conditions of the connections by changing the connection outputs as desired.

Select 2. Contact Test in Test, then the following screen appears.

```

- >   C o n t a c t   T e s t
1 . T / S   1       :   O f f   *
2 . T / S   2       :   O f f
3 . T / S   3       :   O f f
4 . T / S   4       :   O f f
5 . T / S   5       :   O f f
6 . T / S   6       :   O f f
7 . T / S   7       :   O f f
8 . H . A l a r m   :   O n
    
```

To test T/S1 ~ T/S7 connections, after selecting( ▶ ) the desired connection, press ▲▼ Key to change to On, and press ENTER ( ENTER ) Key, then after the connection is activated, it recovers to off state with the sound of "Click".

To test Healthy Alarm connection, select( ▶ ) H.Alarm connection, press ▲▼ Key to change to Off, and press ENTER ( ENTER ) Key, then after the connection is activated, it recovers to On state with the sound of "Click".

Press ◀ Key in Contact Test, then it will exit this menu and convert to the upper menu.



**【Table 6.7】 Setting Menus**

Default Screen Setting (Menu)	1. Measurements			Ia Ib, Ic, In	
	2. Protection	1. Time OCR	1. Curve	OFF, NI, VI, EI, LI, DT, KNI, KVI	
			2. PickUp	2.0~12.5A(0.1A Step)	
			3. Time Dial	0.1~10.0(0.1Step)	
			4. DT_Time	0.04~60.00Sec(0.01Sec Step)	
		2. INST. OCR	1. Mode	OFF, INST, DT	
			2. PickUp	10~90A(1A Step)	
			3. DT_Time	0.04~60.00Sec(0.01Sec Step)	
		3. Time OCGR	1. Curve	OFF, NI, VI, EI, LI, DT, KNI, KVI	
			2. PickUp	0.2~2.5A(0.1A Step)	
			3. Time Dial	0.1~10.0(0.1Step)	
			4. DT_Time	0.04~60.00Sec(0.01Sec Step)	
		4. INST. OCGR	1. Mode	OFF, INST, DT	
	2. PickUp		2~50A(1A Step)		
	3. DT_Time		0.04~60.00Sec(0.01Sec Step)		
	3. Self-Diagnosis			Power Fail, CPU Watchdog, CPU Memory, Setting	
	4. RS-485 comm.	1. Protocol		MODBUS	
		2. Baudrate		300, 600, 1200, 2400, 4800, 9600, 19200 (bps)	
		3. Slave Addr		1~254	
	5. System Config.	1. Power System	1. FREQ	50Hz or 60Hz	
			2. P_CT_RAT	5~10000:5 (5 Step)	
			3. G_CT_RAT	5~10000:5 (5 Step)	
		2. T/S OutPut	1. T/S 1~7	1. CON	OFF, PROT_OR, IOCR_OR, IOCR_A, IOCR_B, IOCR_C, TOCR_OR, TOCR_A, TOCR_B, TOCR_C, OCR_A, OCR_B, OCR_C, IOCGR, TOCGR, IOCR+TOCR, IOCR+IOCGR, IOCGR+TOCGR, TOCR+TOCGR
				2. RST	SELF or MANUAL
				3. DLY	0.00~60.00Sec (0.01Sec Step)
		3. Password		New Password :****	
	6. Recorder	1. Display Faults		Counter, Element, Time, Ia, Ib, Ic, In	
2. Clear Faults		Clear All Faults? Yes or No			
7. Test	1. Display Test		Are you sure to Display Test? Yes or No		
	2. Contact Test		T/S 1~7,H.Alarm : on or off		

## 7. PC Software ( SetGDRSeries )

As you change and verify various setting values, fault information, status indications, you can change and verify using PC on the site using this SetGDRSeries. Operate by connecting RS-232C communication port of PC and the RS-232C communication port of the front-side of the relay, and use MODBUS for the communication protocol. Also, RS-485 communication is possible by using the contact at the back. When you change the setting in the relay, you have to repeat changing for each category, but you can process at once using SetGDRSeries, and you can store the operation contents as a file, so it can perform the same operation in the future more easily. All the related operation data is stored as a file, and it can be retrieved.

The following is the default screen when SetGDRSeries is run.

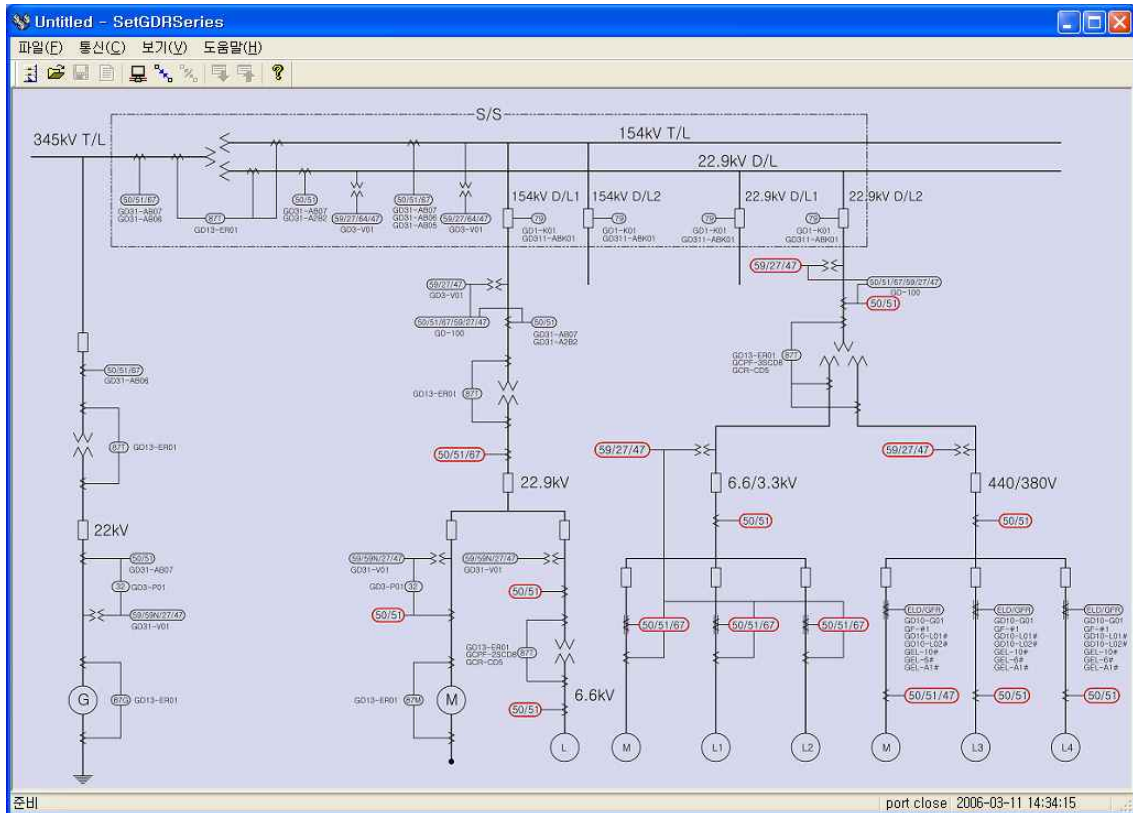









**[Figure 7.1] SetGDRSeries Default Screen**

## 7.1 Program Menu

The basic menu of SetGDRSeries is mainly divided to communication port setting menu, file input/output menu, and relay related setting menu, and please refer to **【Table 7.1】** for the details.

**【Table 7.1】 SetGDRSeries Program Menus**

● Program Menu	
 Comm	Selects the communication port of the computer. Refer to 7.3 Communication Port Setting
 Connect	Connects the communication between the ports of the relay and SetGDRSeries, and initializes.
 Disconnect	Closes the connection of the communication port.
 Device Selecting	Selects the relay to communicate with SetGDRSeries.
 Open	Reads the existing Setting file.
 Save	Stores Setting(System, Protection) contents.
 Report	Stores Setting(Relay Information, System, Protection, Fault) contents as a text file.
 PC → Relay	Transmits the System, Protection setting changes to the relay.
 Relay → PC	Bundle uploads the setting contents of the current relay to the SetGDRSeries.
Exit(X)	Exits the program.

## 7.2 Device Selecting

One SetGDRSeries program controls one GDR Series relay, and the relay to be controlled needs to be selected. Press Relay Select() button, and the window to select the relay appears as the following Figure, and selects the relay to be controlled remotely.

To communicate with GDR-AB01, select GDR-AB01, and press "OK" button.



**【Figure 7.2】** Relay  
Selecting

## 7.3 Communication Port Configuration

This function select and use other Con-Port when the communication port is occupied by other device and not usable, and can select and use among 15 ports for the communication port. Also, since RS-232C communication protocol uses MODBUS, you can use RS-485 communication for SetGDRSeries.









**【Figure 7.3】** Communication Port Setting

**【Table 7.2】 Communication Port Configuration**

• Communication		
Port	COM1 ~ COM15	
	Communication Port	
ADDR	1~254	Used for RS-485C communication
	Slave Address (MODBUS Protocol) for RS-485C	

## 7.4 Setting Update Screen

Select the relay in Relay Select() in SetGDRSeries menu, then the screen to select Setting, Status, Report category appears. From this, press Relay → PC () to verify the stored system configuration and Protection setting, and press PC → Relay () to input the current Setting screen contents to the relay. Also, press Save() to store the Setting screen contents as (\*.gdr) file, and press Open() to load the stored file. Press Report() to store as (\*.txt) file for easy production of reports.

### 7.4.1 Setting

Setting Screen sets the protection relay element and the categories related to the System Configuration of the relay. Setting categories are mainly composed of Time OCR(Time overcurrent relay element), Inst. OCR(Instantaneous overcurrent relay element), Time OCGR(Time ground overcurrent relay element), Inst. OCGR(Instantaneous ground overcurrent relay element), Power System, and T/S Output, and the description of each element is the same as menu screen, so please refer to "6. Display and Setting Mode".

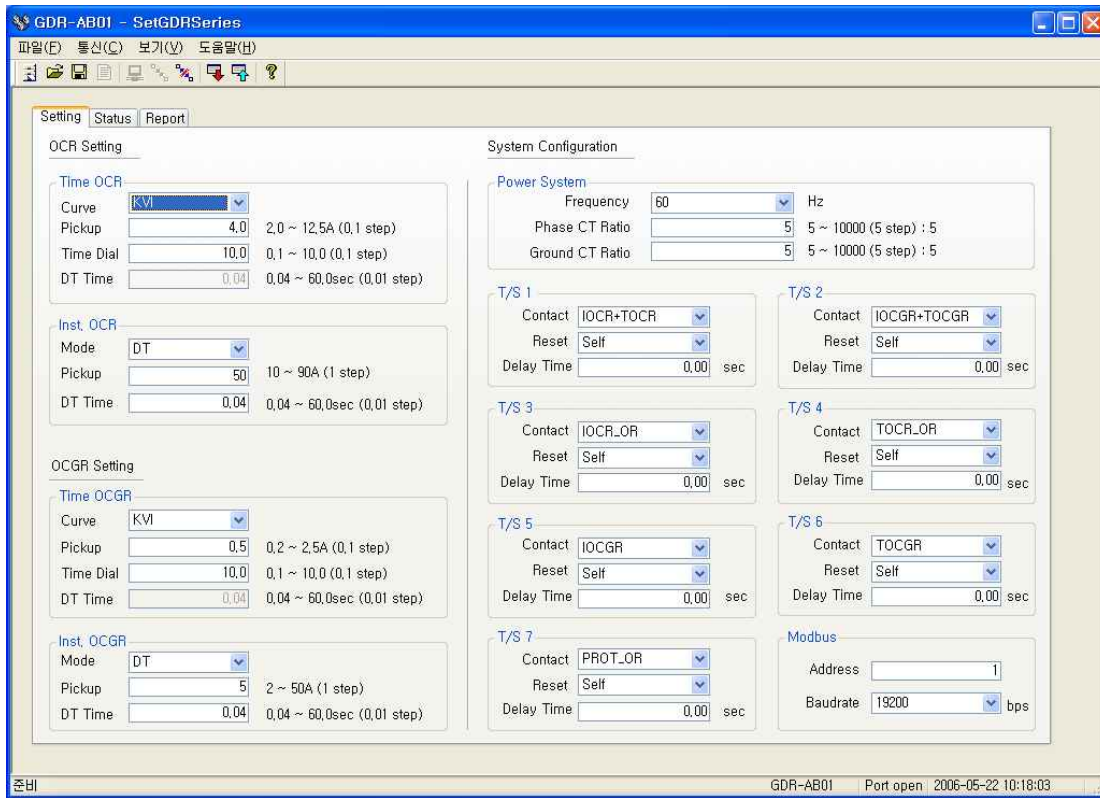

**【Figure 7.4】 GDR-AB01 Setting**

## 7.4.2 Status

Status Screen is composed to view the categories that are displayed in the relay such as Current Measurement, Fault Record, State, etc. in one screen.

The description of this category is the same as the relay menu, so please refer to "6. Display and Setting Mode".

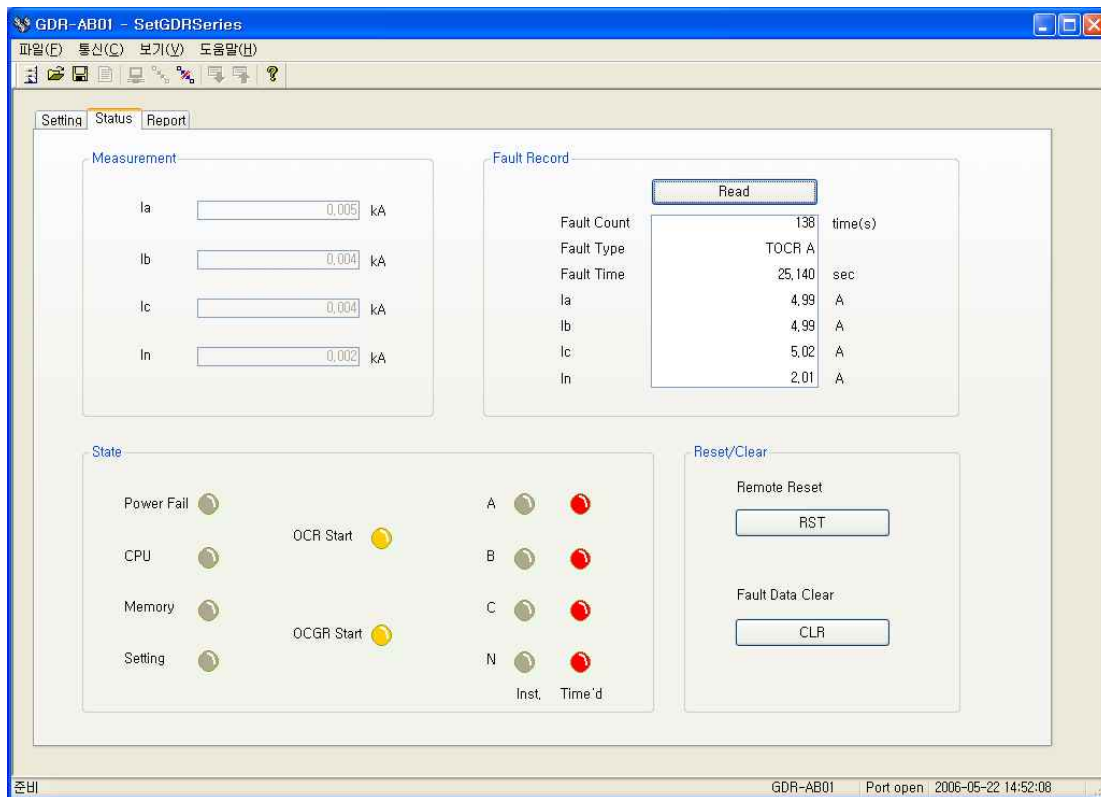

**【Figure 7.5】 GDR-AB01 Status**

- SetGDRSeries Measurement unit is kA.
- Click Read button, then it shows the last fault content stored in the relay.
- Click RST button, then the protection relay element among the **Reset** (  ) **Key** functions of the relay operates, and when Operating Indicator is on, the operation of Indicator Reset can be done remotely at PC.
- Click CLR button, then the same function of **Recorder** ▶ **2.Clear Fault** category of the relay can be done remotely at PC.

### 7.4.3 Report

You can store and read the information(Relay Information, Setting Data, System Configuration, Fault Record) of the relay as txt file format through the communication between the relay and PC.

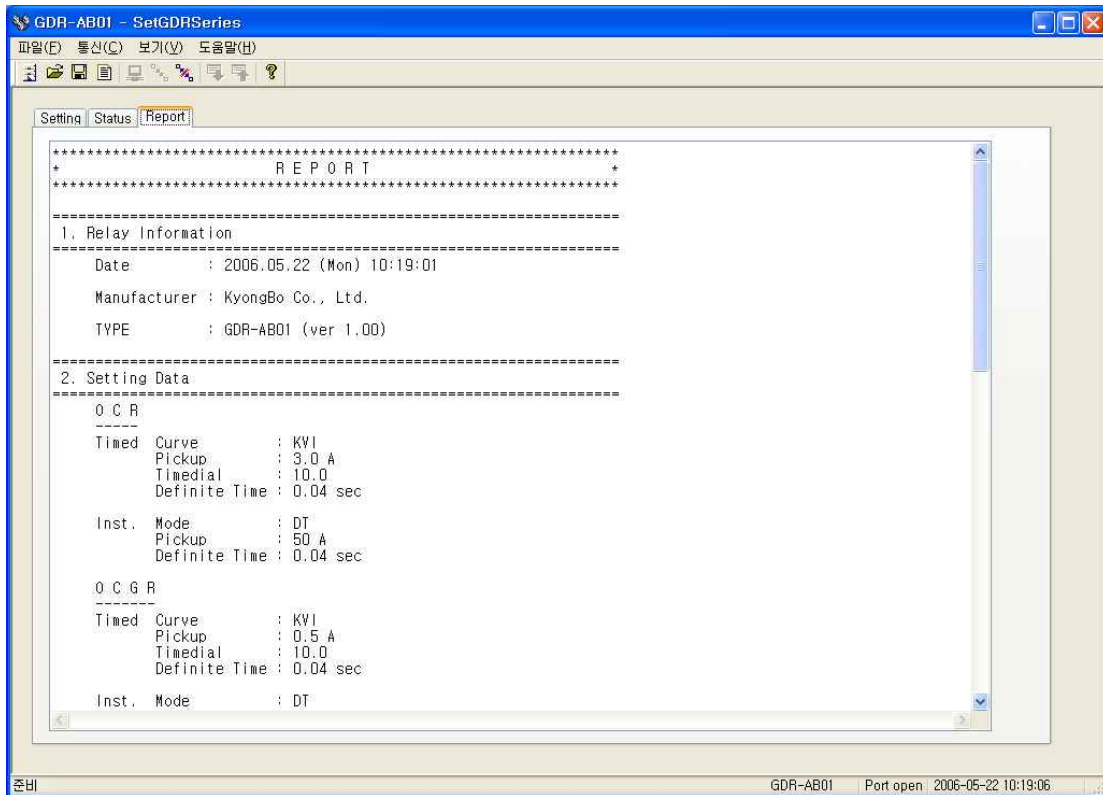

**【Figure 7.6】 GDR-AB01 Report**



## 7.5 Help

You can find the description of Setting Tool functions, technical assistance(A/S), company's homepage, mail address, address, and phone numbers, etc.

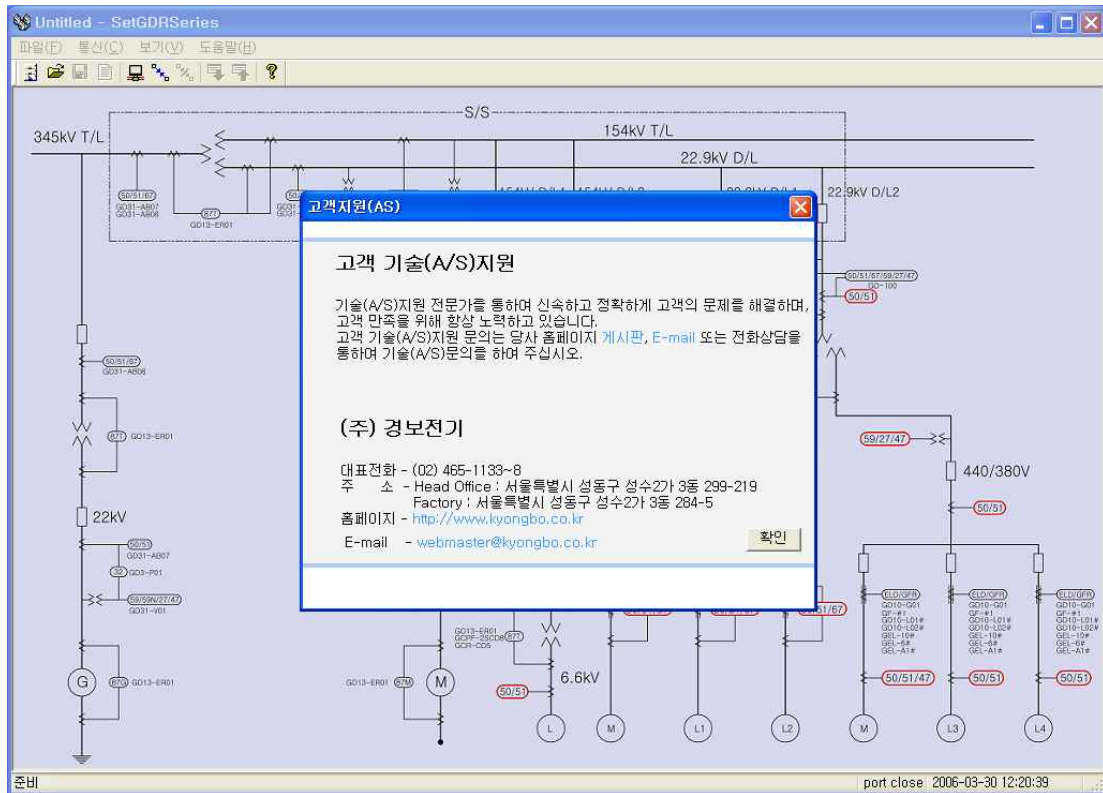

[Figure 7.7] Help

## Appendix 1. Factory Default Setting Values

Default Screen Setting (Menu)	1. Protection	1. Time OCR	1. Curve	KVI	
			2. PickUp	5A	
			3. Time Dial	10	
			4. DT_Time	–	
		2. INST. OCR	1. Mode	DT	
			2. PickUp	50A	
			3. DT_Time	0.04Sec	
		3. Time OCGR	1. Curve	KVI	
			2. PickUp	0.5A	
			3. Time Dial	10	
			4. DT_Time	–	
		4. INST. OCGR	1. Mode	DT	
			2. PickUp	5A	
			3. DT_Time	0.04Sec	
		2. RS-485 comm.	1. Baudrate		19200[bps]
			2. Slave Addr		1
	3. System Config.	1. Power System	1. FREQ		60Hz
			2. P_CT_RAT		5 : 5
			3. G_CT_RAT		5 : 5
		2. T/S OutPut	T/S1	1. CON	PROT_OR
				2. RST	SELF
				3. DLY	0.00Sec
			T/S2	1. CON	IOCR_OR
				2. RST	SELF
				3. DLY	0.00Sec
			T/S3	1. CON	TOCR_OR
				2. RST	SELF
3. DLY				0.00Sec	
T/S4			1. CON	IOCGR	
			2. RST	SELF	
			3. DLY	0.00Sec	
T/S5		1. CON	TOCGR		
		2. RST	SELF		
		3. DLY	0.00Sec		
T/S6		1. CON	IOCR+TOCR		
		2. RST	SELF		
	3. DLY	0.00Sec			
T/S7	1. CON	IOCGR+TOCGR			
	2. RST	SELF			
	3. DLY	0.00Sec			
3. Password			0000		

## Appended 1. Dimensioned Drawings Unit : mm

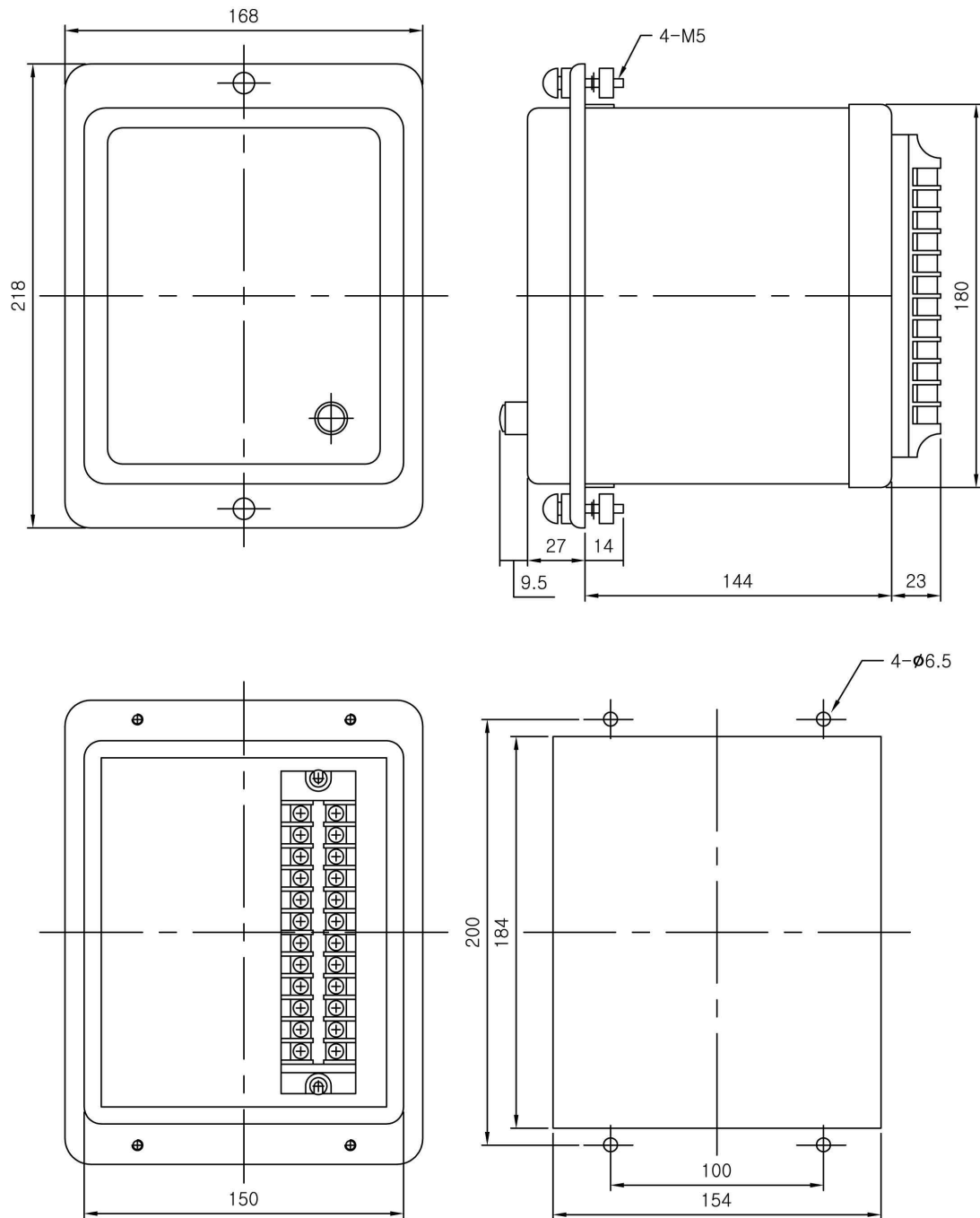

## Appended 2. Internal Block Diagram

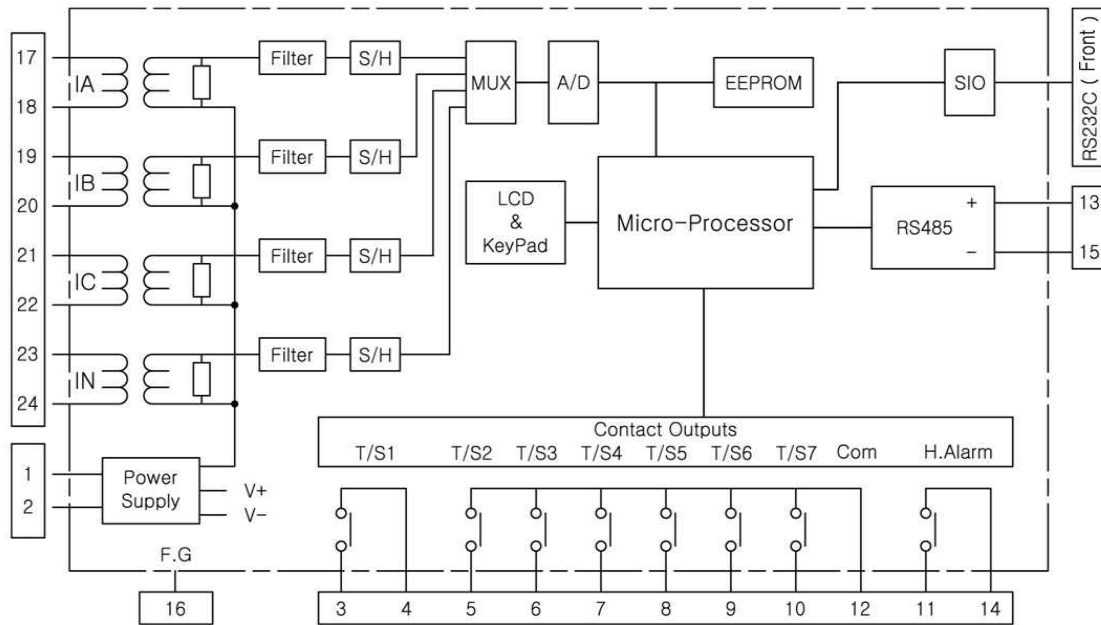

## Appended 3. External Connection Diagram

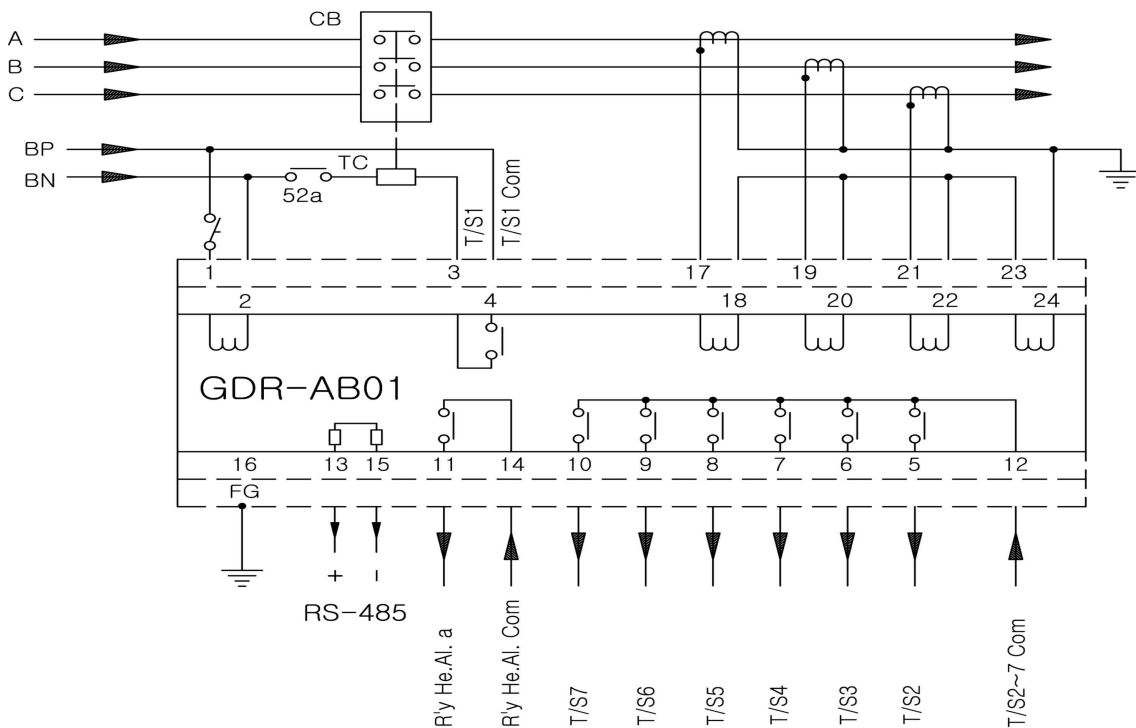

- \* Cation : 1) External connection diagram is example.  
 2) R'y.He.Al contact out status is normal  
 when apply aux. power

## Appended 4. Inverse Time Characteristic Curve

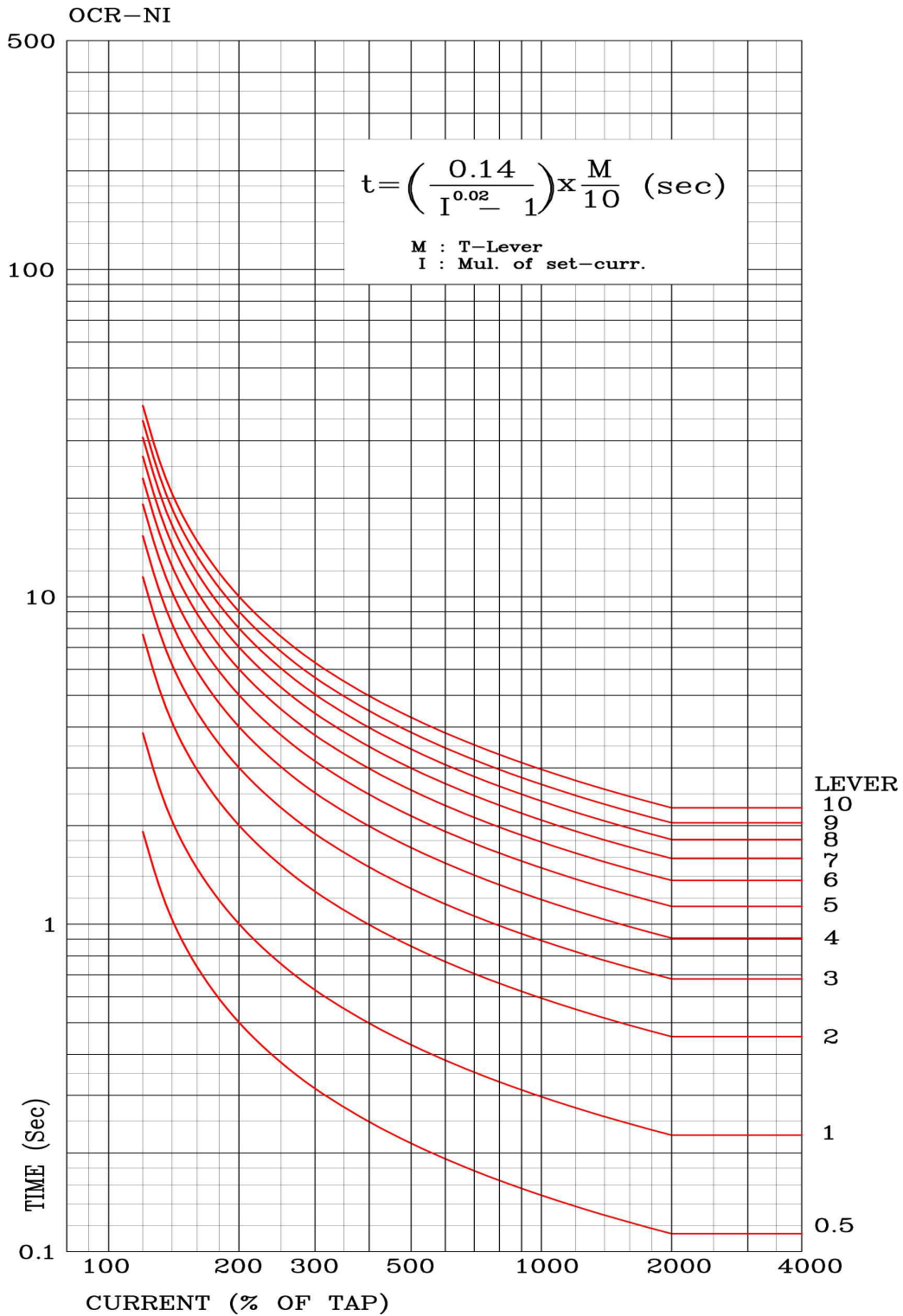

## Appended 5. Very Inverse Time Characteristic Curve

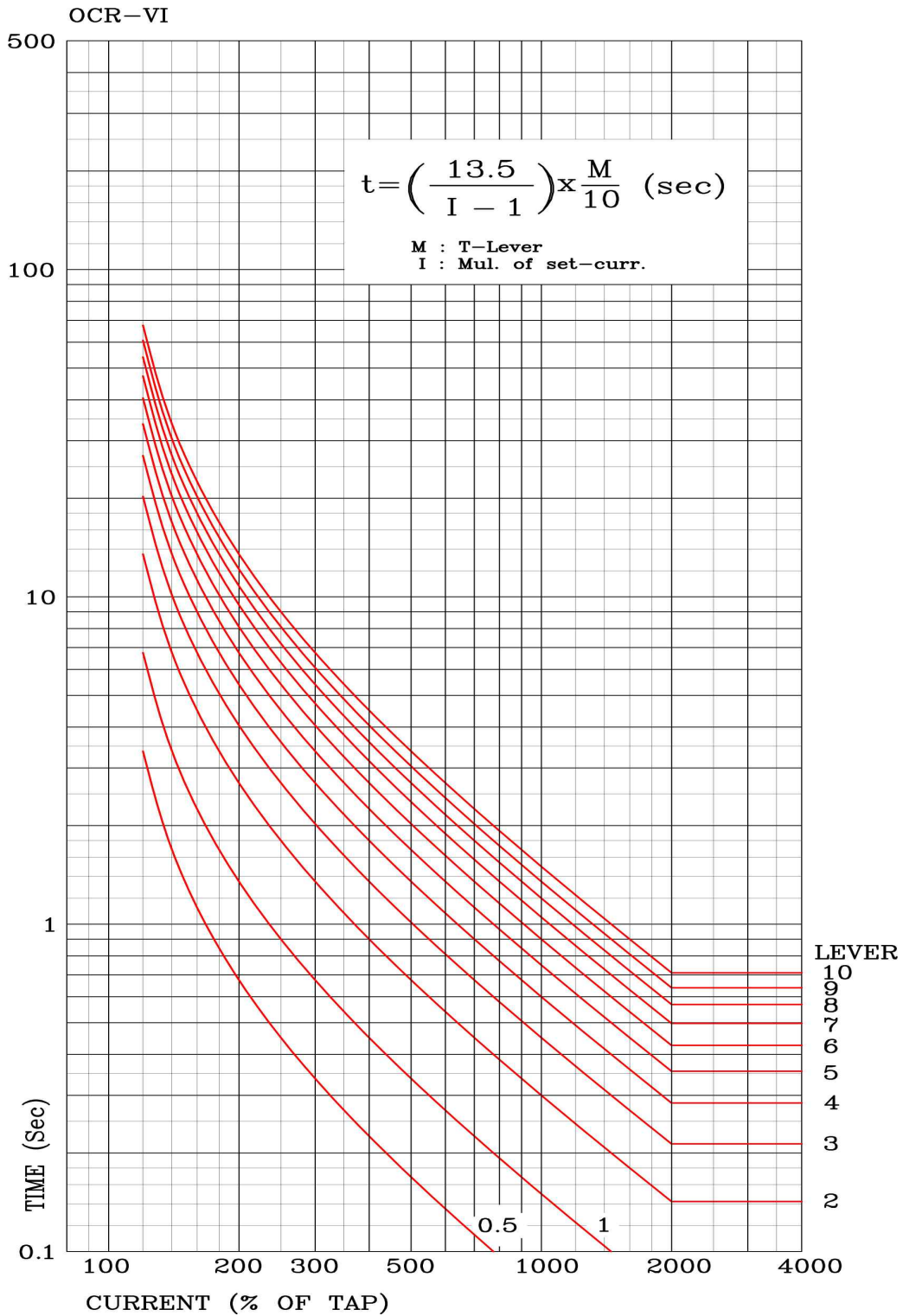

## Appended 6. Extreme Inverse Time Characteristic Curve

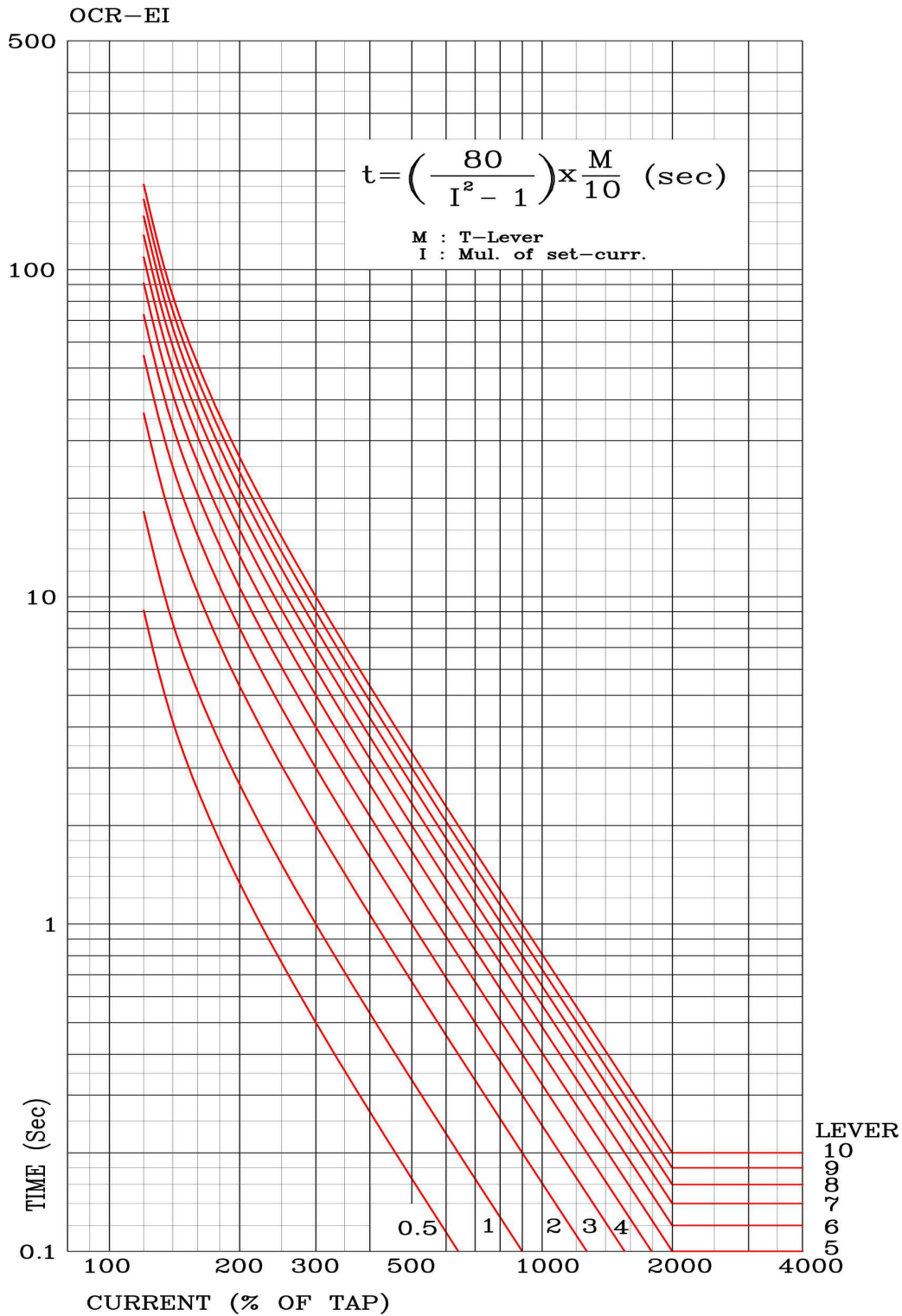

## Appended 7. Long Inverse Time Characteristic Curve

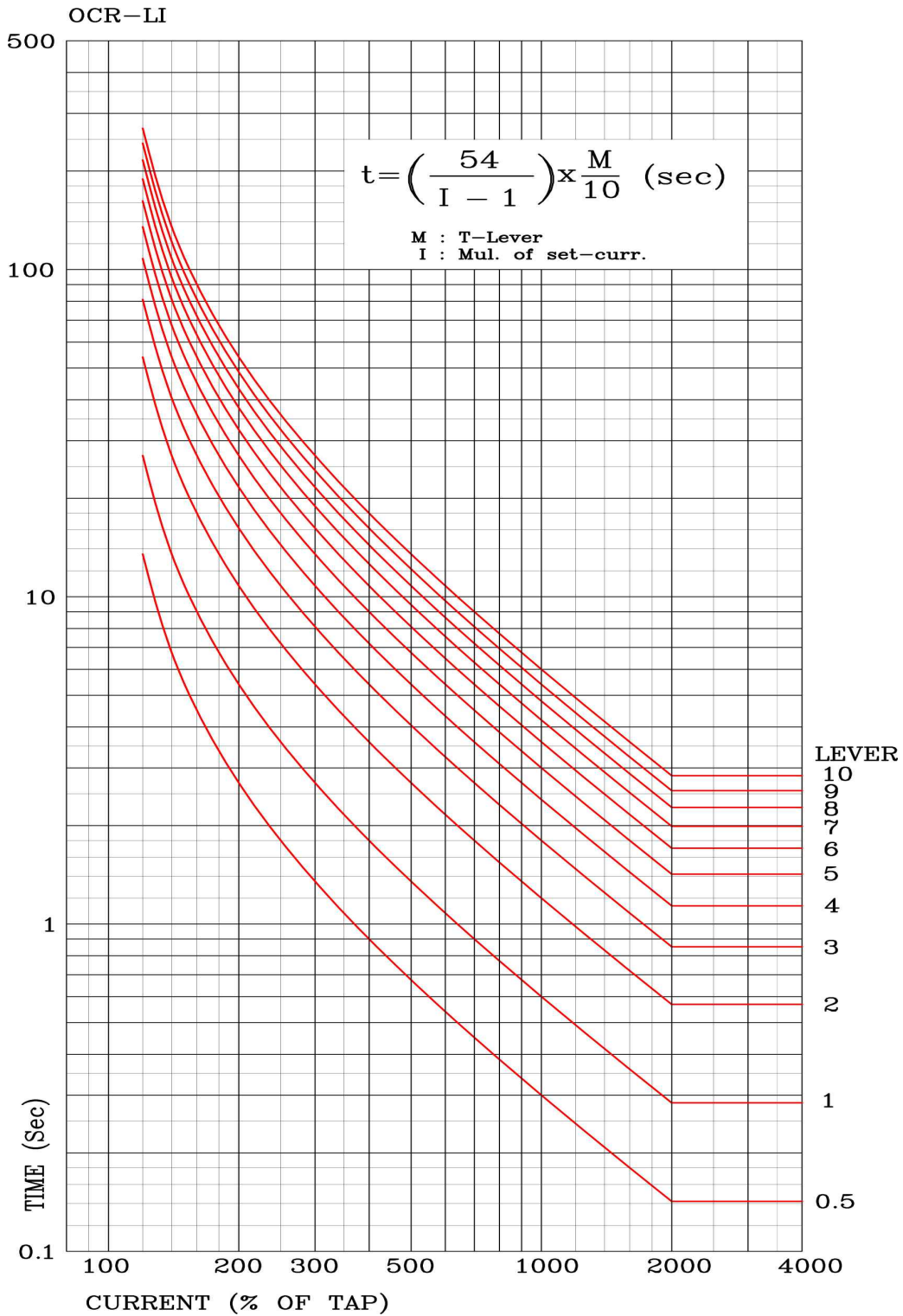



## Appended 8. Kyongbo Induction Type Inverse Time (KEPCO Type) Characteristic Curve

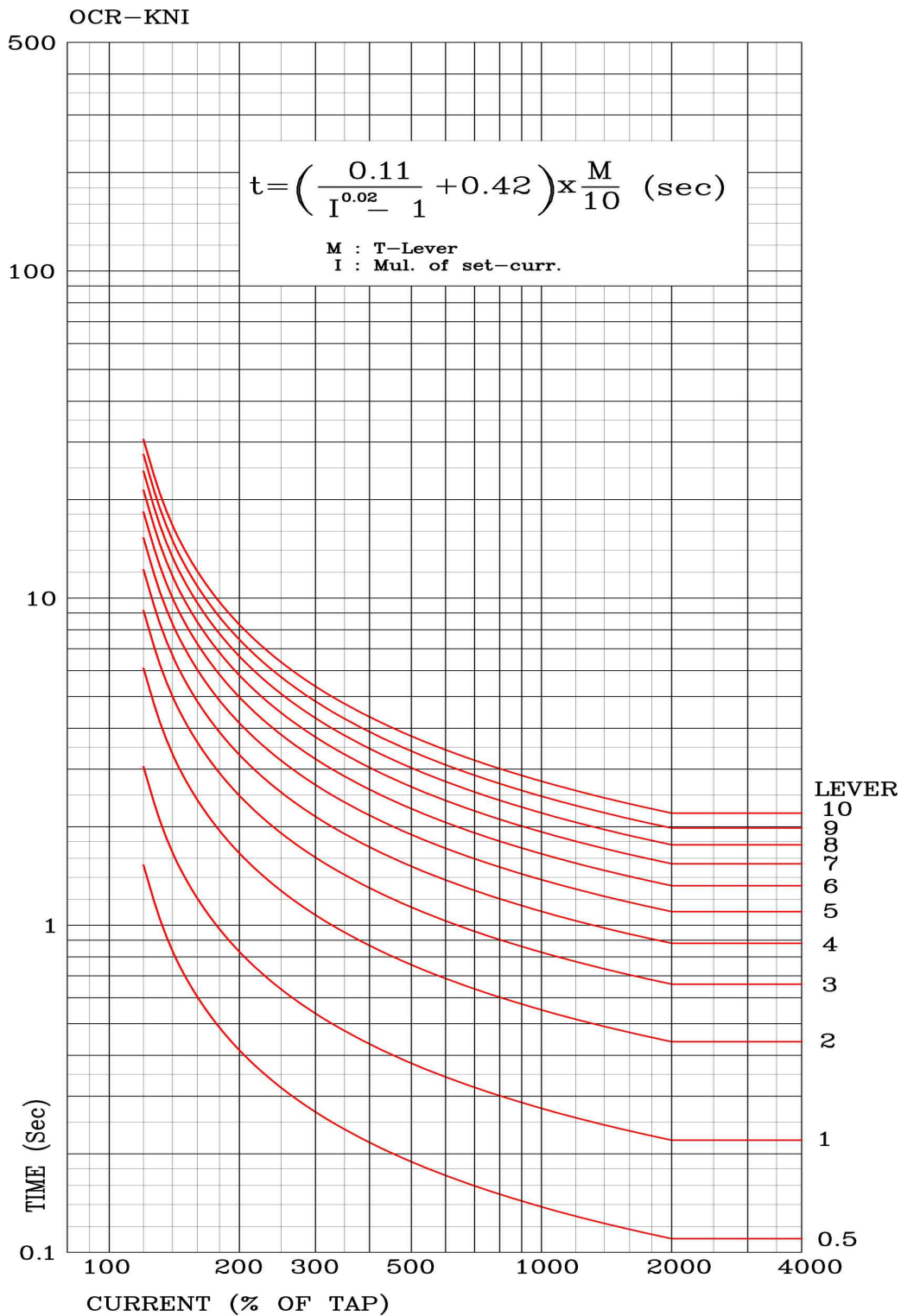

## Appended 9. Kyongbo Induction Type Very Inverse Time (KEPCO Type) Characteristic Curve

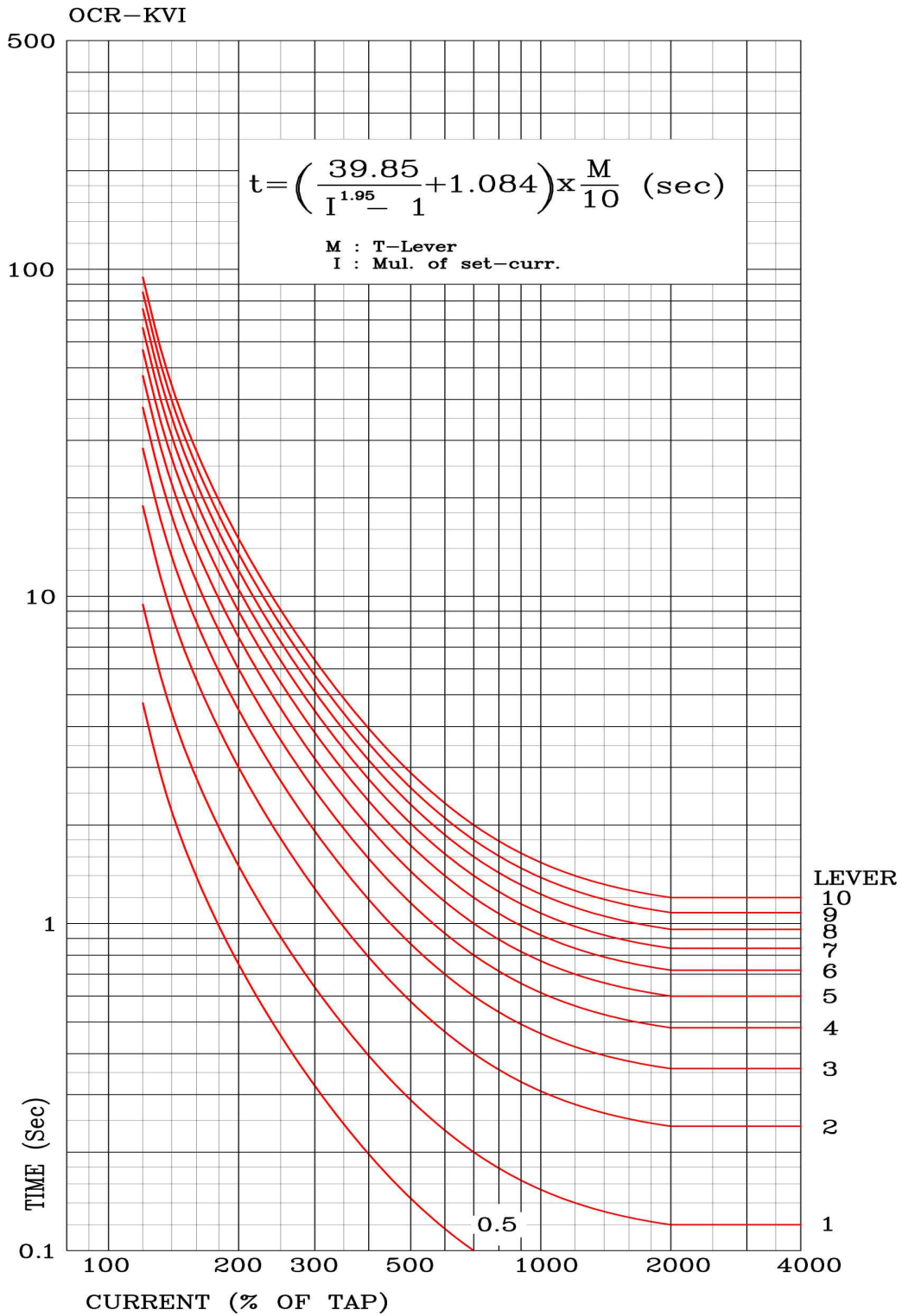

## Appended 10. Definite Time Characteristic Curve

